

Tahké™

How To Order

1. State Quantity
2. Specify Model Number
3. Bamboo Color
 - Amber
 - Natural
 - Neapolitan - Meeting Tables Only
4. Drawer Style
 - Standard Bamboo
 - Vinyl Wrap
5. Specify Options

Listed by each product group are options specific to those items. Options with an asterisk (*) are mandatory to make an order complete. Options without an asterisk will be made standard if not otherwise specified.

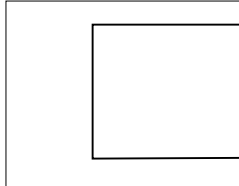

Straight Edge

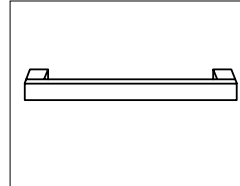

Tahké™ Hardware

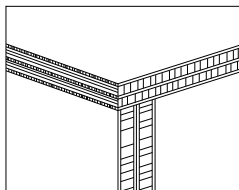

Exposed Grain Detail

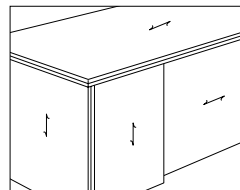

Desk Grain Direction

Modesty panel runs horizontal

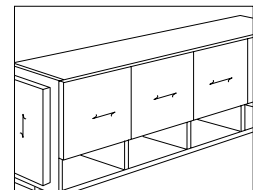

Overhead Grain Direction

Doors and back panel run horizontal

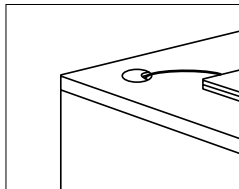

Grommet

Optional for some items-- check individual product selection.

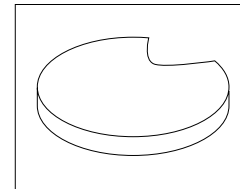

Top Grommet

Natural or Amber, specified to match unit finish.

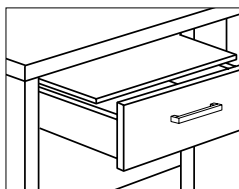

Concealed Touch Latch Writing Tablet

Standard for some items-- check individual product selection.

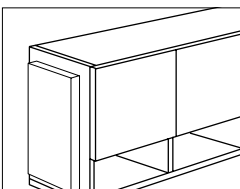

Overhead Storage

Must be secured to end panel, storage tower, or wardrobe on both sides for support. Worklights included; tackboard sold separately.

Tahké™ Specifications

Materials

Bamboo Plywood

All exterior surfaces are comprised of 100% bamboo plywood. The bamboo plant is harvested at maturity (five or six years) and replants itself which makes it a rapidly renewable resource. Tahké™ bamboo plywood is produced using strong adhesives which are formaldehyde free.

Work Surfaces - 1" thick - 5 cross ply bamboo, exposed edge grain;
Neapolitan meeting table tops are ¾" thick - 3 cross ply bamboo

Desk End Panels - 1½" thick - 5 cross ply bamboo, exposed edge grain

All other panels - ¾" thick - 3 cross ply bamboo, exposed edge grain

Pedestal backs - Fiberboard with no added formaldehyde

The product edges are flat, exposing the ply of the bamboo and creating a greater conservation during manufacturing.

The bamboo plywood is a natural product without stains. There are two main colors of bamboo: amber and natural. Amber is created through a heat transfer process. The nature of this product may cause tone variations. Tahké™ meeting tables are also available in neapolitan, a mixture of the two colors.

The bamboo plywood hardness and durability is similar to oak. Bamboo is a plant and not a tree. As with most fine furniture, it is not recommended for Tahké™ to be placed in areas of high humidity or areas of extreme dry climates.

Note: Some interior rails used for support may be made from solid hardwood lumber; such as poplar or maple wood. This is done to maximize materials and to eliminate waste during the manufacturing process.

Hardware and Trim

Case Pulls - Fabricated buffed steel with a satin nickel finish

Drawer Slides - Pressed formed steel with natural finish

Standard Drawers - Five sided box style drawer box members ½" edge grain bamboo plywood in natural - tenon and mortise construction.

Optional Drawers - Five sided box, miter fold construction, drawer box members are vinyl wrapped MDF.

Optional Grommet Inserts - Round with wire crescent shape opening for wire pass through, made of ½" edge grain bamboo.

Tackboard - The eco-balanced bulletin board linoleum surface is a tackable surface made from renewable materials. The surface is adhered to an emission free particle board substrate.

Sleeve Connector Bolts - Steel oxide finish

Locking System - Locking system is a bar style system. Pedestal locks are standard. Optional locks are available on doors.

Lighting - Lighting is high efficiency integrated electronic ballast and compact fluorescent puck lights with high output. The lights use seven (7) watts and have the same output as a 20-watt halogen light. Each overhead unit includes four (4) lights.

Case Construction

Pedestal backs utilize tongue and groove construction. Pedestal sides are reinforced with cross stretchers which are bore and dowel assembled. Dowels are pretreated with a fast activating water based glue to ensure the proper adhesion.

Case construction is based on a 32mm grid pattern with three 10mm diameter by 30mm long dowels placed at each end of the joints. Rafix Connector Bolt System is used in special joint areas such as overheads. All cases are calibrated by auto air-driven case clamps.

Finish

All work surface tops are coated in a UV cured water based finish for extreme durability. All other surfaces are finished in a water based sealer and top coat.

On Site Assembly

Most cabinets and cases are fully assembled at the factory. Overhead cabinets are assembled and need to be connected to work surface towers or floor storage cabinets. Special stilts are provided for installation along with instructions.

Note: Installation stilts can be returned for a refund of \$75.

Tahké™ Sustainability Overview

Jhane Barnes



Jofco collaborated with celebrated designer Jhane Barnes to create a completely green casegoods solution. Every detail – glue, veneer and wood species is sustainable. “It is our responsibility to regard the issues of sustainability at all levels,” says Jhane Barnes. “In designing Tahké™, I selected materials that reflect that responsibility.”

The most important material element of Tahké™ is bamboo. To ensure sustainable practices were used in creating the bamboo plywood for Tahké™, Jhane and Jofco partnered with Plyboo™, a company fully committed to environmentally sound practices. The bamboo plywood incorporated in Tahké™ is a no added urea formaldehyde product, and offers hardness and durability qualities similar to oak.

- 1 All exterior surfaces of Tahké™ are comprised of bamboo plywood. Bamboo is rapidly renewable, taking only five to six years to mature. It is self-regenerative, requiring no planting, pesticides, or fertilizers. Only fully mature stalks are harvested not the entire plant, leaving the forest intact through a naturally sustainable cycle.

The bamboo plywood of Tahké™ is produced using strong adhesives which are urea formaldehyde free.

Two colors available for Tahké™ casegoods: natural and amber. The slightly darker amber color is created through a heat-transfer process. As a result of using natural colors, not stains, tone variations occur.

- 2 Work surfaces are 1” thick 5 cross-ply bamboo with exposed edge grain. Using the panels in this state create interest while conserving the energy normally expended in the creation of edge details.

Work surfaces are coated in a UV-cured, water-based finish for extreme durability. All other surfaces are finished using a water-based sealer and top coat.

- 3 Cases are constructed with a dowel assembly and reinforced with bolts in certain joint areas. Dowels are pretreated with a fast activating water-based glue to ensure proper adhesion. Pedestal backs utilize tongue and groove construction.

- 4 Desk end panels are 1½” thick 5-ply bamboo with exposed edge grain. Using the panels in this state creates interest while conserving the energy normally expended in the creation of edge details.

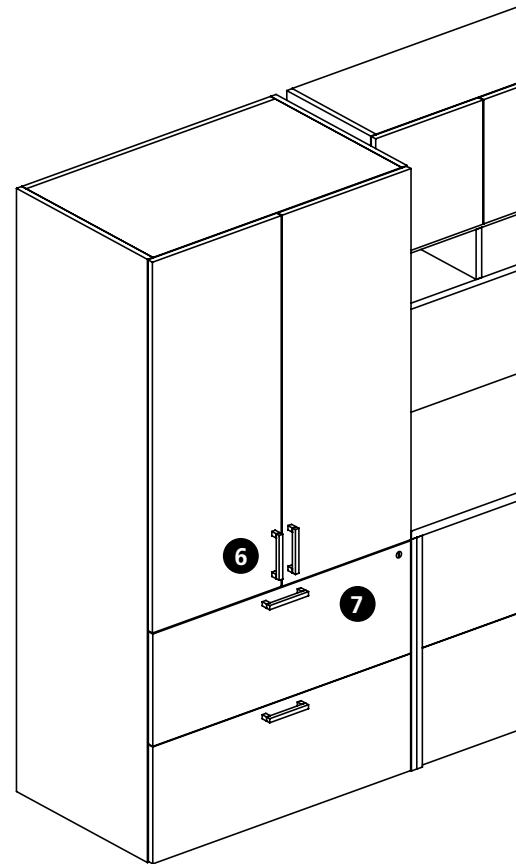

Tahké™ incorporates bamboo with no added urea formaldehyde. Low-emitting adhesives and sealants are used throughout the product manufacturing. Approximately 95% of the materials used in manufacturing Tahké™ are environmentally preferable and can be recycled or reused after use.

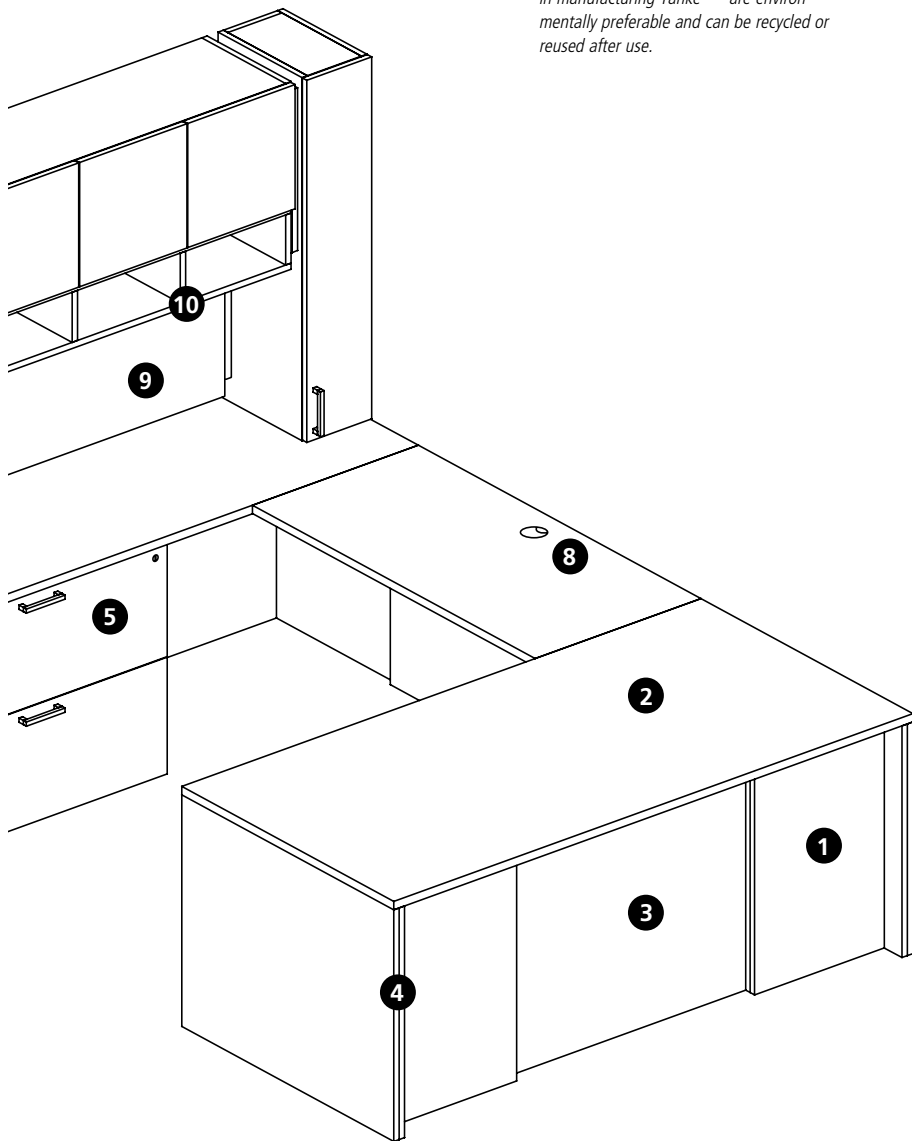

- 5 Pedestal backs are comprised of fiber-board with no added formaldehyde.
- 6 Hardware is fabricated buffed steel with satin nickel finish recyclable after use.
- 7 Standard drawers are made from 1/2" natural edge grain bamboo plywood.
- 8 To eliminate the need for additional materials, the optional round grommets are produced from 1/2" edge grain bamboo and given a crescent shape cut-out for wire pass through.
- 9 The eco-balanced linoleum bulletin board is made from ecologically responsible materials, consumes very little energy in the manufacturing process, and is considered an emission-free particle board substrate.
- 10 Lighting is achieved with a highly efficient electronic ballast and four compact fluorescent puck lights. The same output of halogen lights is achieved using only a third of the wattage.

Tahké™ Typicals

Double Pedestal Desk with Storage

Model Number	Description	Page	Price
TH1DPR1-3672	Double Pedestal Desk	10	\$6658
TH5FDS1L-1509	9" w Worksurface Storage Tower	20	\$1661
TH4BBW1-1563	63" w Overhead Storage	18	\$3936
TH9HTB1-0363	Tackboard	18	\$1188
TH2STL1-2472	Lateral File Credenza	14	\$3872
TH6ADT1R-2418	18" w Tall Wardrobe	21	\$3284
Workstation List Price			\$20,599

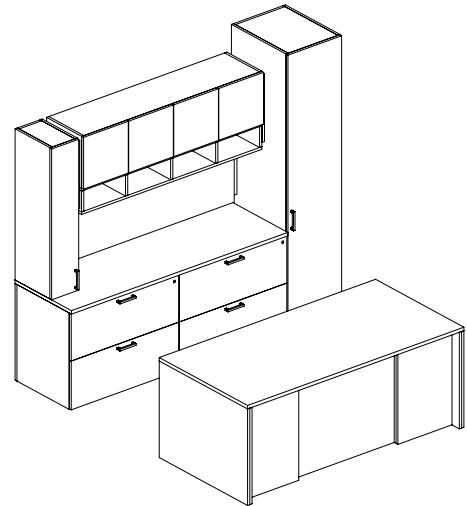

L Shape Configuration with Storage

Model Number	Description	Page	Price
TH1SPR1L-3672	Single Pedestal Desk	11	\$5103
TH3RTR1R-2548	48" w Return	14	\$2440
TH4BBW1-1563	63" w Overhead Storage	18	\$3936
TH9HTB1-0363	Tackboard	18	\$1188
TH5FDS1L-1509	9" w Tall Worksurface Storage Tower	20	\$1661
TH6ADS1L-2412	12" w Wardrobe	22	\$2457
Workstation List Price			\$16,785

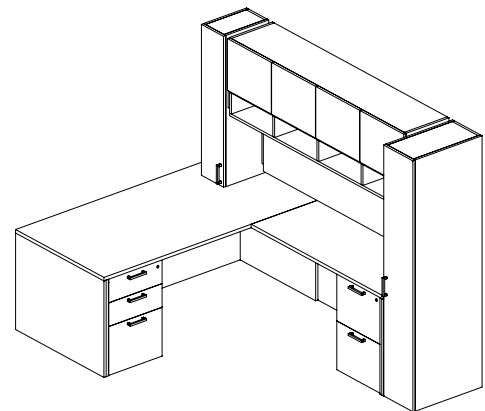

Bullet Top L Shape Configuration with Storage

Model Number	Description	Page	Price
TH1LRU1-3060	Bullet Top Run-Off Desk	12	\$1600
TH2OCP1R-2472	Open Corner Credenza	15	\$3587
TH4BBW1-1563	63" w Overhead Storage Tower	18	\$3936
TH9HTB1-0363	Tackboard	18	\$1188
TH5FDT1R-1509	9" w Tall Worksurface Storage Tower	19	\$1767
TH6ADL1L-2418	18" w Low Wardrobe	23	\$2883
Workstation List Price			\$14,961

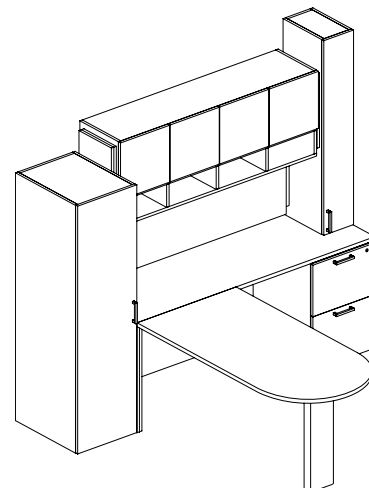





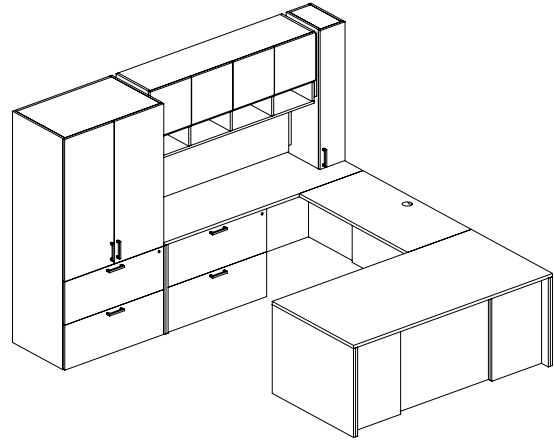

Tahké™ Typical

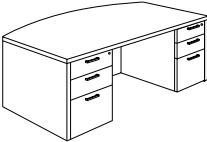
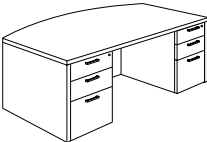
U Shape Configuration with Back Storage

Model Number	Description	Page	Price
TH1SPR1R-3672	Single Pedestal Desk	11	\$5103
TH3BMR1-2542	Bridge with optional grommet (\$165)	13	\$1403
TH2OCL1L-2472	Open Corner Lateral File Credenza	15	\$3915
TH4BBW1-1563	63" w Overhead Storage	18	\$3936
TH9HTB1-0363	Tackboard	18	\$1188
TH5FDS1R-1509	9" w Worksurface Storage Tower	20	\$1661
TH6DDS2-2436	36" w Storage Unit with Lateral File	22	\$5531
Workstation List Price			\$22,737

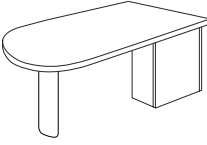

DESKS	DESCRIPTION/NOTES	MODEL	W	D	H	PRICE
	84\"w Bow Front Double Pedestal Desk Standard Features flat edge with exposed grain detail pencil/box/file pedestals concealed touch latch writing tablet on pencil/box/file only letter filing front to back; legal filing side to side locking drawers wire management tray 2½\" adjustable glides kneespace height: 27¾\" front overhang: 12¾\" top size: 36\"/43\"d	TH1DPB1-4384	84	43	28¾	7136
	Specify Options 1. amber or natural bamboo color* 2. vinyl wrapped drawer, deduct \$270 3. file/file pedestal left, no upcharge 4. file/file pedestal right, no upcharge 5. grommet, add \$165 each (specify location)					
	72\"w Bow Front Double Pedestal Desk Standard Features flat edge with exposed grain detail pencil/box/file pedestals concealed touch latch writing tablet on pencil/box/file only letter filing front to back; legal filing side to side locking drawers wire management tray 2½\" adjustable glides kneespace height: 27¾\" -4172 front overhang: 10¾\" -3672 front overhang: 7¾\" -4172 top size: 36\"/41\"d -3672 top size: 30\"/35¼\"d	TH1DPB1-4172 TH1DPB1-3672	72	41	28¾	6858 6298
	Specify Options 1. amber or natural bamboo color* 2. vinyl wrapped drawer, deduct \$270 3. file/file pedestal left, no upcharge 4. file/file pedestal right, no upcharge 5. grommet, add \$165 each (specify location)					
	Double Pedestal Desk Standard Features flat edge with exposed grain detail pencil/box/file pedestals concealed touch latch writing tablet on pencil/box/file only letter filing front to back; legal filing side to side locking drawers wire management tray 2½\" adjustable glides kneespace height: 27¾\" -3684 front overhang: 5¾\" -3672 front overhang: 5¾\" -3072 front overhang: 2½\"	TH1DPR1-3684 TH1DPR1-3672 TH1DPR1-3072	84	36	28¾	6928 6658 6115
	Specify Options 1. amber or natural bamboo color* 2. vinyl wrapped drawer, deduct \$270 3. file/file pedestal left, no upcharge 4. file/file pedestal right, no upcharge 5. grommet, add \$165 each (specify location)					
 left shown	72\"w Bow Front Single Pedestal Desk Standard Features flat edge with exposed grain detail pencil/box/file pedestal concealed touch latch writing tablet on pencil/box/file only letter filing front to back; legal filing side to side locking drawers wire management tray 2½\" adjustable glides kneespace height: 27¾\" -4172 front overhang: 10¾\" -3672 front overhang: 7¾\" -4172 top size: 36\"/41\"d -3672 top size: 30\"/35¼\"d	TH1SPB1L-4172 TH1SPB1R-4172 TH1SPB1L-3672 TH1SPB1R-3672	72	41	28¾	5256 5256 4708 4708
	Specify Options 1. amber or natural bamboo color* 2. vinyl wrapped drawer, deduct \$135 3. file/file pedestal, no upcharge 4. grommet, add \$165 each (specify location)					

DESKS	DESCRIPTION/NOTES	MODEL	W	D	H	PRICE
 <p>left shown</p>	66" w Bow Front Single Pedestal Desk Standard Features flat edge with exposed grain detail pencil/box/file pedestal concealed touch latch writing tablet on pencil/box/file only letter filing front to back; legal filing side to side locking drawers wire management tray 2½" adjustable glides kneespace height: 27¾" -4166 front overhang: 10" -3666 front overhang: 6¾" -4166 top size: 36"/41" d -3666 top size: 30"/35¼" d	TH1SPB1L-4166	66	41	28¾	5051
		TH1SPB1R-4166	66	41	28¾	5051
		TH1SPB1L-3666	66	35¼	28¾	4426
		TH1SPB1R-3666	66	35¼	28¾	4426
	Specify Options 1. amber or natural bamboo color* 2. vinyl wrapped drawer, deduct \$135 3. file/file pedestal, no upcharge 4. grommet, add \$165 each (specify location)					
 <p>left shown</p>	72" w Single Pedestal Desk Standard Features flat edge with exposed grain detail pencil/box/file pedestal concealed touch latch writing tablet on pencil/box/file only letter filing front to back; legal filing side to side locking drawers wire management tray 2½" adjustable glides kneespace height: 27¾" -3672 front overhang: 5¾" -3072 front overhang: 2½"	TH1SPR1L-3672	72	36	28¾	5103
		TH1SPR1R-3672	72	36	28¾	5103
		TH1SPR1L-3072	72	30	28¾	4571
		TH1SPR1R-3072	72	30	28¾	4571
	Specify Options 1. amber or natural bamboo color* 2. vinyl wrapped drawer, deduct \$135 3. file/file pedestal, no upcharge 4. grommet, add \$165 each (specify location)					
 <p>left shown</p>	66" w Single Pedestal Desk Standard Features flat edge with exposed grain detail pencil/box/file pedestal concealed touch latch writing tablet on pencil/box/file only letter filing front to back; legal filing side to side locking drawers wire management tray 2½" adjustable glides kneespace height: 27¾" -3666 front overhang: 5¾" -3066 front overhang: 2½"	TH1SPR1L-3666	66	36	28¾	4687
		TH1SPR1R-3666	66	36	28¾	4687
		TH1SPR1L-3066	66	30	28¾	4205
		TH1SPR1R-3066	66	30	28¾	4205
	Specify Options 1. amber or natural bamboo color* 2. vinyl wrapped drawer, deduct \$135 3. file/file pedestal, no upcharge 4. grommet, add \$165 each (specify location)					
 <p>left shown</p>	72-1/4" w Bullet Top Desk Standard Features use in U-shape configurations flat edge with exposed grain detail top veneer direction long grain pedestal grain is vertical 2¼" x 8¼" bamboo post 2½" adjustable glides fixed utility shelf: 6 x 18"	TH1LEU1L-3672	72¼	35¼	28¾	3358
		TH1LEU1R-3672	72¼	35¼	28¾	3358
		TH1LEU1L-3072	72¼	30	28¾	3007
		TH1LEU1R-3072	72¼	30	28¾	3007
	Specify Options 1. amber or natural bamboo color* 2. grommet, add \$165 each (specify location)					

How To Order:

Specify model number and options listed with each product section. **Options marked with an asterisk are required.** Failure to do so will delay order processing. Options without an asterisk will be made standard if not otherwise specified.
EX: TH1DPB1-4384.Natural.

DESKS	DESCRIPTION/NOTES	MODEL	W	D	H	PRICE
  left shown	60" w Bullet Top Desk Standard Features use in U-shape configurations flat edge with exposed grain detail top veneer direction long grain pedestal grain is vertical 2 1/4" x 8 1/4" bamboo post 2 1/2" adjustable glides fixed utility shelf: 6 x 18"	TH1LEU1L-3060 TH1LEU1R-3060	60	30	28 3/4	2845
			60	30	28 3/4	2845
  left shown	72-1/4" w Bullet Top Desk with Modesty Panel Standard Features use in U-shape configurations flat edge with exposed grain detail top veneer direction long grain 2 1/4" x 8 1/4" bamboo post recessed full modesty panel pedestal grain is vertical modesty panel grain is horizontal 2 1/2" adjustable glides	TH1LEU8L-3672 TH1LEU8R-3672 TH1LEU8L-3072 TH1LEU8R-3072	72 1/4	35 3/4	28 3/4	3566
			72 1/4	35 3/4	28 3/4	3566
			72 1/4	30	28 3/4	3026
			72 1/4	30	28 3/4	3026
  left shown	60" w Bullet Top Desk with Modesty Panel Standard Features use in U-shape configurations flat edge with exposed grain detail top veneer direction long grain 2 1/4" x 8 1/4" bamboo post recessed full modesty panel pedestal grain is vertical modesty panel grain is horizontal 2 1/2" adjustable glides	TH1LEU8L-3060 TH1LEU8R-3060	60	30	28 3/4	3180
			60	30	28 3/4	3180
  left shown	36" d Bullet Top Run-Off Desk with Modesty Panel Standard Features use in L-shape configurations flat edge with exposed grain detail top veneer direction long grain 2 1/4" x 8 1/4" bamboo post recessed full modesty panel modesty panel grain is horizontal 2 1/2" adjustable glides	TH1LRU8L-3666 TH1LRU8R-3666	66	36	28 3/4	2059
			66	36	28 3/4	2059
  left shown	30" d Bullet Top Run-Off Desk with Modesty Panel Standard Features use in L-shape configurations flat edge with exposed grain detail top veneer direction long grain 2 1/4" x 8 1/4" bamboo post recessed full modesty panel modesty panel grain is horizontal 2 1/2" adjustable glides	TH1LRU8L-3060 TH1LRU8R-3060 TH1LRU8L-3054 TH1LRU8R-3054	60	30	28 3/4	1781
			60	30	28 3/4	1781
			54	30	28 3/4	1679
			54	30	28 3/4	1679

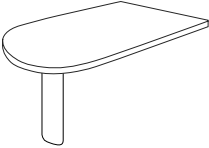
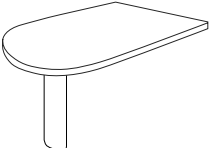
DESKS	DESCRIPTION/NOTES	MODEL	W	D	H	PRICE
	35-3/4" d Bullet Top Run-Off Desk Standard Features use in L-shape configurations flat edge with exposed grain detail veneer direction long grain 2 1/4" x 8 1/4" bamboo post 2 1/2" adjustable glides	TH1LRU1-3666	66	35 3/4	28 3/4	1851
		Specify Options 1. amber or natural bamboo color* 2. grommet, add \$165 each (specify location)				
	30" d Bullet Top Run-Off Desk Standard Features use in L-shape configurations flat edge with exposed grain detail veneer direction long grain 2 1/4" x 8 1/4" bamboo post 2 1/2" adjustable glides	TH1LRU1-3060	60	30	28 3/4	1600
		TH1LRU1-3054	54	30	28 3/4	1525
		Specify Options 1. amber or natural bamboo color* 2. grommet, add \$165 each (specify location)				

How To Order:

Specify model number and options listed with each product section. **Options marked with an asterisk are required.** Failure to do so will delay order processing. Options without an asterisk will be made standard if not otherwise specified.
EX: TH1DPB1-4384.Natural.

RETURNS	DESCRIPTION/NOTES	MODEL	W	D	H	PRICE
---------	-------------------	-------	---	---	---	-------

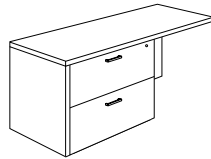

left shown

Lateral Return

TH3RTL1L-2554	54	24¾	28¾	3317
TH3RTL1R-2554	54	24¾	28¾	3317

Standard Features

flat edge with exposed grain detail
vener direction long grain
reinforced drawer bottoms each drawer
letter filing front to back; legal filing side to side or front to back
locking drawers
2½" adjustable glides
kneespace width: 16½"
kneespace height: 27¾"

Specify Options

1. amber or natural bamboo color*
2. vinyl wrapped drawer, deduct \$145
3. grommet, add \$165 each (specify location)

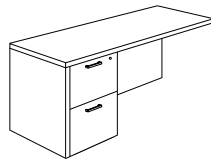

left shown

54" w Return

TH3RTR1L-2554	54	24¾	28¾	2505
TH3RTR1R-2554	54	24¾	28¾	2505

Standard Features

flat edge with exposed grain detail
vener direction long grain
file/file pedestal
letter filing front to back; legal filing side to side
locking drawers
2½" adjustable glides
kneespace width: 34½"
kneespace height: 27¾"

Specify Options

1. amber or natural bamboo color*
2. vinyl wrapped drawer, deduct \$130
3. box/box/file, no upcharge
4. grommet, add \$165 each (specify location)

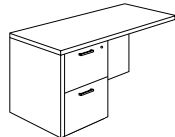

left shown

48" w Return

TH3RTR1L-2548	48	24¾	28¾	2440
TH3RTR1R-2548	48	24¾	28¾	2440

Standard Features

flat edge with exposed grain detail
vener direction long grain
file/file pedestal
letter filing front to back; legal filing side to side
locking drawers
2½" adjustable glides
kneespace width: 28½"
kneespace height: 27¾"

Specify Options

1. amber or natural bamboo color*
2. vinyl wrapped drawer, deduct \$130
3. box/box/file, no upcharge
4. grommet, add \$165 each (specify location)

BRIDGES	DESCRIPTION/NOTES	MODEL	W	D	H	PRICE
---------	-------------------	-------	---	---	---	-------

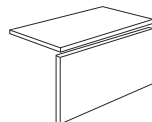
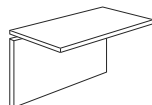

Bridge with Modesty Panel



TH3BMR1-2548	47¾	24¾	28¾	1376
TH3BMR1-2542	41¾	24¾	28¾	1238
TH3BMR1-2536	35¾	24¾	28¾	1114

Standard Features

bridge top attaches to worksurfaces;
modesty panel attaches to lower panels
leaving wire management pass-thru
flat edge with exposed grain detail
vener direction long grain
2½" adjustable glides



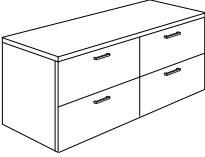

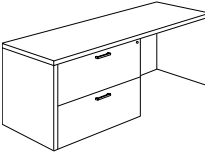
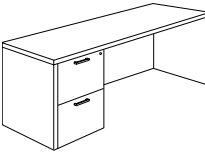
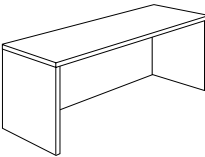
Specify Options



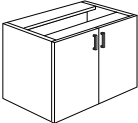

1. amber or natural bamboo color*
2. grommet, add \$165 each (specify location)

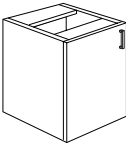
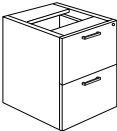
CRENZAS	DESCRIPTION/NOTES	MODEL	W	D	H	PRICE
	<p>Lateral File Credenza</p> <p>Standard Features flat edge with exposed grain detail four lateral files, 36" reinforced drawer bottoms each drawer locking drawers unfinished back 2½" adjustable glides</p>	TH2STL1-2472	72	24	28¾	3872
	<p>Specify Options 1. amber or natural bamboo color* 2. vinyl wrapped drawer, deduct \$290 3. finished back, add \$439</p>					
	<p>Storage Credenza</p> <p>Standard Features flat edge with exposed grain detail two hinged door compartments with adjustable shelf two box/box/file locking drawers unfinished back 2½" adjustable glides</p>	TH2HPD1-2472	72	24	28¾	4513
	<p>Specify Options 1. amber or natural bamboo color* 2. vinyl wrapped drawer, deduct \$270 3. file/file, no upcharge 4. locking doors, add \$222 5. finished back, add \$439</p>					
	<p>Open Corner Lateral File Credenza</p> <p>Standard Features flat edge with exposed grain detail reinforced drawer bottoms each drawer letter filing front to back; legal filing side to side or front to back locking drawers finished back 2½" adjustable glides kneespace width: 33½"</p>	TH2OCL1L-2472 TH2OCL1R-2472	72 72	24 24	28¾ 28¾	3915 3915
	<p>Specify Options 1. amber or natural bamboo color* 2. vinyl wrapped drawer, deduct \$145 3. grommet, add \$165 each (specify location)</p>					
	<p>Open Corner Credenza</p> <p>Standard Features flat edge with exposed grain detail file/file pedestal letter filing front to back; legal filing side to side locking drawers finished back 2½" adjustable glides kneespace width: 51½"</p>	TH2OCP1L-2472 TH2OCP1R-2472	72 72	24 24	28¾ 28¾	3587 3587
	<p>Specify Options 1. amber or natural bamboo color* 2. box/box/file, no upcharge 3. vinyl wrapped drawer, deduct \$130 4. grommet, add \$165 each (specify location)</p>					
	<p>Credenza Shell</p> <p>Standard Features use with modular pedestals flat edge with exposed grain detail vener direction long grain finished back 2½" adjustable glides</p>	TH2CRS1-2493 TH2CRS1-2490 TH2CRS1-2484 TH2CRS1-2481 TH2CRS1-2472	93 90 84 81 72	24 24 24 24 24	28¾ 28¾ 28¾ 28¾ 28¾	3173 3071 2866 2764 2457
	<p>Specify Options 1. amber or natural bamboo color* 2. grommet, add \$165 each (specify location)</p>					

How To Order:

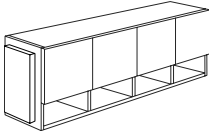
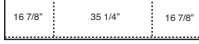
Specify model number and options listed with each product section. **Options marked with an asterisk are required.** Failure to do so will delay order processing. Options without an asterisk will be made standard if not otherwise specified.
EX: TH1DPB1-4384.Natural.

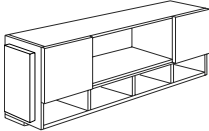
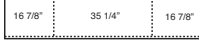
MODULAR COMPONENTS	DESCRIPTION/NOTES	MODEL	W	D	H	PRICE
	36" w Hinge Door Pedestal Standard Features used in credenza shell one adjustable shelf unfinished back 2½" adjustable glides	TH7HDN1-2036	36	20	27½	1702
		Specify Options 1. amber or natural bamboo color* 2. locking doors, add \$111 3. finished back, add \$265				
	36" w Lateral File Pedestal Standard Features used in credenza shell reinforced drawer bottoms each drawer letter filing front to back; legal filing side to side or front to back locking drawers unfinished back 2½" adjustable glides	TH7FLN1-2036	36	20	27½	2002
		Specify Options 1. amber or natural bamboo color* 2. vinyl wrapped drawer, deduct \$145 3. finished back, add \$265				
 left shown	18" w Hinge Door Standard Features used in credenza shell one adjustable shelf unfinished back 2½" adjustable glides	TH7HDN1L-2018 TH7HDN1R-2018	18 18	20 20	27½ 27½	1410 1410
		Specify Options 1. amber or natural bamboo color* 2. locking doors, add \$111 3. finished back, add \$180				
	18" w File/File Pedestal Standard Features used in credenza shell letter filing front to back; legal filing side to side locking drawers unfinished back 2½" adjustable glides	TH7PUN1-2018	18	20	27½	1557
		Specify Options 1. amber or natural bamboo color* 2. vinyl wrapped drawer, deduct \$130 3. finished back, add \$180				
	18" w Box/Box/File Pedestal Standard Features used in credenza shell letter filing front to back; legal filing side to side locking drawers unfinished back 2½" adjustable glides	TH7PUNA-2018	18	20	27½	1594
		Specify Options 1. amber or natural bamboo color* 2. vinyl wrapped drawer, deduct \$135 3. finished back, add \$180				

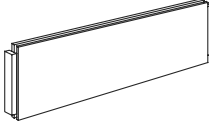
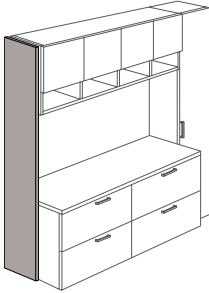
OVERHEAD STORAGE	DESCRIPTION/NOTES	MODEL	W	D	H	PRICE
	Overhead Storage with Paper Management Standard Features must use with worksurface towers or wardrobes/support panels exposed grain detail three compartments in upper section door grain direction horizontal finger groove in bottom of door four compact fluorescent lights bamboo spacers attached on both sides bored on both sides finished back	TH4BBW1-1575	75	15	23	4543
		TH4BBW1-1563	63	15	23	3936
 72 inch shown, top view, inside measurements						
 60 inch shown, top view, inside measurements						
	Overhead Storage with Open Center Standard Features must use with worksurface towers or wardrobes/support panels exposed grain detail three compartments in upper section door grain direction horizontal finger groove in bottom of door four compact fluorescent lights bamboo spacers attached on both sides bored on both sides finished back	TH4BBW4-1575	75	15	23	4179
		TH4BBW4-1563	63	15	23	3689
 72 inch shown, top view, inside measurements						
 60 inch shown, top view, inside measurements						
	Tackboard Standard Features must use with worksurface towers or wardrobes/support panels tackable linoleum surface bored on both sides bamboo spacers attached on both sides	TH9HTB1-0375	75	3	17	1391
		TH9HTB1-0363	63	3	17	1188
	End Panel Standard Features 2½" adjustable glides	TH0FST1-1502	1½	15	79¼	1414
		TH0FSS1-1502	1½	15	71¼	1336
		TH0FSL1-1502	1½	15	64	1258

How To Order:

Specify model number and options listed with each product section. **Options marked with an asterisk are required.** Failure to do so will delay order processing. Options without an asterisk will be made standard if not otherwise specified.
EX: TH1DPB1-4384.Natural.

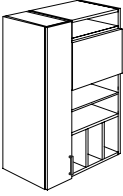
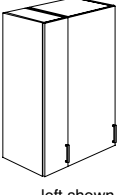
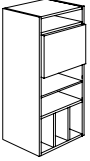
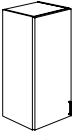
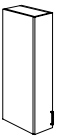

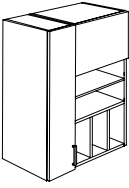
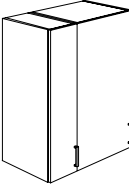
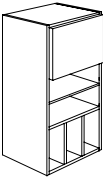
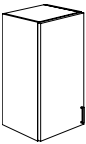
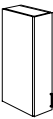

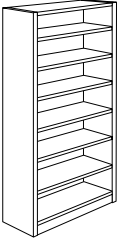
51"H WORKSURFACE STORAGE TOWERS	DESCRIPTION/NOTES	MODEL	W	D	H	PRICE
 <p>left shown</p>	27" Tall Storage Tower Standard Features exposed grain detail finished back 9" tower three adjustable shelves CD holder (holds 18 CD's) 18" tower fixed storage areas horizontal shelves (adjustable) vertical shelves (fixed) bored for attachment opposite hinge	TH5TST8L-1527	27	15	51	3383
		TH5TST8R-1527	27	15	51	3383
		Specify Options 1. amber or natural bamboo color* 2. locking doors, add \$222				
 <p>left shown</p>	27" Tall Storage Tower Standard Features exposed grain detail finished back 9" tower three adjustable shelves CD holder (holds 18 CD's) 18" tower three adjustable shelves bored for attachment opposite hinge	TH5FDT1L-1527	27	15	51	3173
		TH5FDT1R-1527	27	15	51	3173
		Specify Options 1. amber or natural bamboo color* 2. locking doors, add \$222				
	18" Tall Storage Tower Standard Features exposed grain detail fixed storage areas horizontal shelves (adjustable) vertical shelves (fixed) finished back bored for attachment opposite hinge	TH5TST8L-1518	18	15	51	2213
		TH5TST8R-1518	18	15	51	2213
		Specify Options 1. amber or natural bamboo color* 2. locking door, add \$111				
 <p>left shown</p>	18" Tall Storage Tower Standard Features exposed grain detail three adjustable shelves finished back bored for attachment opposite hinge	TH5FDT1L-1518	18	15	51	1966
		TH5FDT1R-1518	18	15	51	1966
		Specify Options 1. amber or natural bamboo color* 2. locking door, add \$111				
 <p>left shown</p>	9" Tall Storage Tower Standard Features exposed grain detail three adjustable shelves CD holder (holds 18 CD's) finished back bored for attachment opposite hinge	TH5FDT1L-1509	9	15	51	1767
		TH5FDT1R-1509	9	15	51	1767
		Specify Options 1. amber or natural bamboo color* 2. locking door, add \$111				

43-1/4"H WORKSURFACE STORAGE TOWERS	DESCRIPTION/NOTES	MODEL	W	D	H	PRICE
 <p>left shown</p>	27" w Storage Tower Standard Features exposed grain detail finished back 9" tower two adjustable shelves CD holder (holds 18 CD's) 18" tower fixed storage areas horizontal shelves (adjustable) vertical shelves (fixed) bored for attachment opposite hinge	TH5TSS8L-1527 TH5TSS8R-1527	27	15	43¼	2998 2998
		Specify Options 1. amber or natural bamboo color* 2. locking doors, add \$222				
 <p>left shown</p>	27" w Storage Tower Standard Features exposed grain detail finished back 9" tower two adjustable shelves CD holder (holds 18 CD's) 18" tower three adjustable shelves bored for attachment opposite hinge	TH5FDS1L-1527 TH5FDS1R-1527	27	15	43¼	2914 2914
		Specify Options 1. amber or natural bamboo color* 2. locking doors, add \$222				
	18" w Storage Tower Standard Features exposed grain detail fixed storage areas horizontal shelves (adjustable) vertical shelves (fixed) finished back bored for attachment opposite hinge	TH5TSS8L-1518 TH5TSS8R-1518	18	15	43¼	1921 1921
		Specify Options 1. amber or natural bamboo color* 2. locking door, add \$111				
 <p>left shown</p>	18" w Storage Tower Standard Features exposed grain detail two adjustable shelves finished back bored for attachment opposite hinge	TH5FDS1L-1518 TH5FDS1R-1518	18	15	43¼	1767 1767
		Specify Options 1. amber or natural bamboo color* 2. locking door, add \$111				
 <p>left shown</p>	9" w Storage Tower Standard Features exposed grain detail three adjustable shelves CD holder (holds 18 CD's) finished back bored for attachment opposite hinge	TH5FDS1L-1509 TH5FDS1R-1509	9	15	43¼	1661 1661
		Specify Options 1. amber or natural bamboo color* 2. locking door, add \$111				

BOOKCASES	DESCRIPTION/NOTES	MODEL	W	D	H	PRICE
	Bookcase	TH0BKC6-1536	36	15	79¼	2292
		TH0BKC4-1536	36	15	71¼	2091
		TH0BKC3-1536	36	15	64¼	1901
		TH0BKC2-1536	36	15	27¼	1711
	Standard Features exposed grain detail adjustable shelves unfinished back 2½" adjustable glides	Specify Options 1. amber or natural bamboo color* 2. finished back TH0BKC6-1536, add \$659, TH0BKC4-1536, add \$550, TH0BKC3-1536, add \$506, TH0BKC2-1536, add \$265 3. boring for attachment to overheads (specify left or right)				

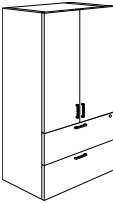
How To Order:

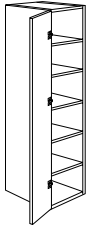
Specify model number and options listed with each product section. **Options marked with an asterisk are required.** Failure to do so will delay order processing. Options without an asterisk will be made standard if not otherwise specified.
EX: TH1DPB1-4384.Natural.

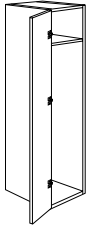
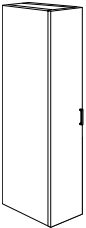
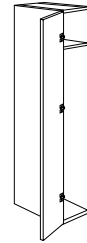
79-1/4"H STORAGE/ WARDROBES	DESCRIPTION/NOTES	MODEL	W	D	H	PRICE
	<p>36" w Tall Storage Unit with Lateral File</p> <p>Standard Features exposed grain detail adjustable shelves letter filing front to back; legal filing side to side or front to back two locking lateral file drawers reinforced drawer bottoms each drawer unfinished back 2½" adjustable glides</p>	<p>TH6DDT2-2436</p>	36	23¾	79¼	5711
	<p>Specify Options 1. amber or natural bamboo color* 2. vinyl wrapped drawer, deduct \$145 3. finished back, add \$659 4. locking door, add \$111 5. boring for attachment to overheads (specify left or right)</p>					
 	<p>18" w Tall Storage Unit</p> <p>Standard Features exposed grain detail top shelf fixed four adjustable shelves unfinished back 2½" adjustable glides</p> <p>left shown</p>	<p>TH6ADT2L-2418 TH6ADT2R-2418</p>	18	23¾	79¼	3681 3681
	<p>Specify Options 1. amber or natural bamboo color* 2. locking door, add \$111 3. finished back, add \$333 4. boring for attachment to overheads (specify left or right)</p>					
 	<p>18" w Tall Wardrobe</p> <p>Standard Features exposed grain detail fixed shelf hanger bar unfinished back 2½" adjustable glides</p> <p>left shown</p>	<p>TH6ADT1L-2418 TH6ADT1R-2418</p>	18	23¾	79¼	3284 3284
	<p>Specify Options 1. amber or natural bamboo color* 2. locking door, add \$111 3. finished back, add \$333 4. boring for attachment to overheads (specify left or right)</p>					
 	<p>12" w Tall Wardrobe</p> <p>Standard Features exposed grain detail fixed shelf hanger bar unfinished back 2½" adjustable glides</p> <p>left shown</p>	<p>TH6ADT1L-2412 TH6ADT1R-2412</p>	12	23¾	79¼	2627 2627
	<p>Specify Options 1. amber or natural bamboo color* 2. locking door, add \$111 3. finished back, add \$333 4. boring for attachment to overheads (specify left or right)</p>					

How To Order:

Specify model number and options listed with each product section. **Options marked with an asterisk are required.** Failure to do so will delay order processing. Options without an asterisk will be made standard if not otherwise specified.
EX: TH1DPB1-4384.Natural.

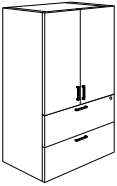
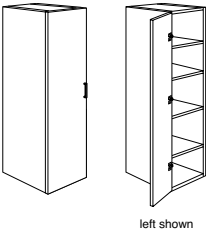
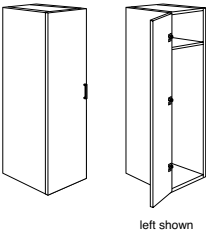
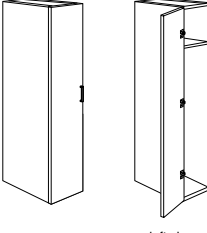
71-3/4"H STORAGE/ WARDROBES	DESCRIPTION/NOTES	MODEL	W	D	H	PRICE
	36" w Storage Unit with Lateral File Standard Features exposed grain detail adjustable shelves letter filing front to back; legal filing side to side or front to back two locking lateral file drawers reinforced drawer bottoms each drawer unfinished back 2½" adjustable glides	TH6DDS2-2436	36	23¾	71¾	5531
	Specify Options 1. amber or natural bamboo color* 2. vinyl wrapped drawer, deduct \$145 3. locking door, add \$111 4. finished back, add \$550 5. boring for attachment to overheads (specify left or right)					
 <p>left shown</p>	18" w Storage Unit Standard Features exposed grain detail top shelf fixed three adjustable shelves unfinished back 2½" adjustable glides	TH6ADS2L-2418 TH6ADS2R-2418	18	23¾	71¾	3426 3426
	Specify Options 1. amber or natural bamboo color* 2. locking door, add \$111 3. finished back, add \$275 4. boring for attachment to overheads (specify left or right)					
 <p>left shown</p>	18" w Wardrobe Standard Features exposed grain detail fixed shelf hanger bar unfinished back 2½" adjustable glides	TH6ADS1L-2418 TH6ADS1R-2418	18	23¾	71¾	3095 3095
	Specify Options 1. amber or natural bamboo color* 2. locking door, add \$111 3. finished back, add \$275 4. boring for attachment to overheads (specify left or right)					
 <p>left shown</p>	12" w Wardrobe Standard Features exposed grain detail fixed shelf hanger bar unfinished back 2½" adjustable glides	TH6ADS1L-2412 TH6ADS1R-2412	12	23¾	71¾	2457 2457
	Specify Options 1. amber or natural bamboo color* 2. locking door, add \$111 3. finished back, add \$275 4. boring for attachment to overheads (specify left or right)					

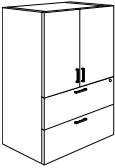
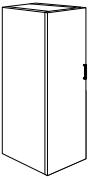
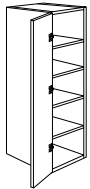
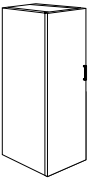
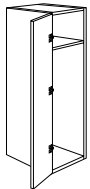
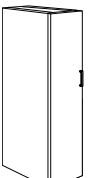
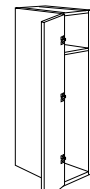
64-1/8"H STORAGE/ WARDROBES	DESCRIPTION/NOTES	MODEL	W	D	H	PRICE
	<p>36" w Low Storage Unit with Lateral File</p> <p>Standard Features exposed grain detail adjustable shelves letter filing front to back; legal filing side to side or front to back two locking lateral file drawers reinforced drawer bottoms each drawer unfinished back 2½" adjustable glides</p>	<p>TH6DDL2-2436</p>	36	23¾	64¾	5302
	<p>Specify Options 1. amber or natural bamboo color* 2. vinyl wrapped drawer, deduct \$145 3. locking door, add \$111 4. finished back, add \$506 5. boring for attachment to overheads (specify left or right)</p>					
	<p>18" w Low Storage Unit</p> <p>Standard Features exposed grain detail top shelf fixed three adjustable shelves unfinished back 2½" adjustable glides</p> <p>left shown</p>	TH6ADL2L-2418	18	23¾	64¾	3147
		TH6ADL2R-2418	18	23¾	64¾	3147
	<p>Specify Options 1. amber or natural bamboo color* 2. locking door, add \$111 3. finished back, add \$258 4. boring for attachment to overheads (specify left or right)</p>					
	<p>18" w Low Wardrobe</p> <p>Standard Features exposed grain detail fixed shelf hanger bar unfinished back 2½" adjustable glides</p> <p>left shown</p>	TH6ADL1L-2418	18	23¾	64¾	2883
		TH6ADL1R-2418	18	23¾	64¾	2883
	<p>Specify Options 1. amber or natural bamboo color* 2. locking door, add \$111 3. finished back, add \$258 4. boring for attachment to overheads (specify left or right)</p>					
	<p>12" w Low Wardrobe</p> <p>Standard Features exposed grain detail fixed shelf hanger bar unfinished back 2½" adjustable glides</p> <p>left shown</p>	TH6ADL1L-2412	12	23¾	64¾	2263
		TH6ADL1R-2412	12	23¾	64¾	2263
	<p>Specify Options 1. amber or natural bamboo color* 2. locking door, add \$111 3. finished back, add \$258 4. boring for attachment to overheads (specify left or right)</p>					

How To Order:

Specify model number and options listed with each product section. **Options marked with an asterisk are required.** Failure to do so will delay order processing. Options without an asterisk will be made standard if not otherwise specified.
EX: TH1DPB1-4384.Natural.

LATERAL FILES	DESCRIPTION/NOTES	MODEL	W	D	H	PRICE
---------------	-------------------	-------	---	---	---	-------



Four Drawer Lateral File	TH6FLT1-2436	36	24	53½	4192
---------------------------------	---------------------	----	----	-----	-------------

Standard Features

flat edge with exposed grain detail
reinforced drawer bottoms each drawer
locking drawers
unfinished back
2½" adjustable glides

Specify Options

1. amber or natural bamboo color*
2. vinyl wrapped drawer, deduct \$290
3. finished back, add \$408



Three Drawer Lateral File	TH6FLM1-2436	36	24	41¼	3418
----------------------------------	---------------------	----	----	-----	-------------

Standard Features

flat edge with exposed grain detail
reinforced drawer bottoms each drawer
locking drawers
unfinished back
2½" adjustable glides

Specify Options

1. amber or natural bamboo color*
2. vinyl wrapped drawer, deduct \$218
3. finished back, add \$306



Two Drawer Lateral File	TH6FLS1-2436	36	24	28½	2002
--------------------------------	---------------------	----	----	-----	-------------

Standard Features

flat edge with exposed grain detail
reinforced drawer bottoms each drawer
locking drawers
unfinished back
2½" adjustable glides

Specify Options

1. amber or natural bamboo color*
2. vinyl wrapped drawer, deduct \$145
3. finished back, add \$265

MOBILE PEDESTALS	DESCRIPTION/NOTES	MODEL	W	D	H	PRICE
------------------	-------------------	-------	---	---	---	-------



Mobile Pedestal	TH7MBP1-2316	15½	22¼	28	1600
------------------------	---------------------	-----	-----	----	-------------

Standard Features

flat edge with exposed grain detail
pull cut-out in top
pencil/box/file pedestal
locking drawers
two locking and two non-locking casters

Specify Options

1. amber or natural bamboo color*
2. vinyl wrapped drawer, deduct \$125

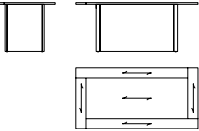
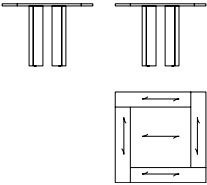
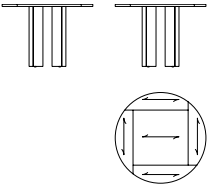
MEETING TABLES	DESCRIPTION/NOTES	MODEL	W	D	H	B1	B2
	<p>Rectangular Table</p> <p>Standard Features amber or natural bamboo top is 1" thick neapolitan bamboo top is ¾" thick base grain detail is horizontal</p>	<p>TH8JRP1-3672</p>	72	36	28¾	3768	4281
	<p>Specify Options 1. amber or natural bamboo color, see column B1; neapolitan bamboo, see column B2*</p>						
	<p>Square Table</p> <p>Standard Features amber or natural bamboo top is 1" thick neapolitan bamboo top is ¾" thick 2¼" bamboo post</p>	<p>TH8JQP1-4242 TH8JQP1-3636</p>	42 36	42 36	28¾ 28¾	2515 2037	2844 2315
	<p>Specify Options 1. amber or natural bamboo color, see column B1; neapolitan bamboo, see column B2*</p>						
	<p>Round Table</p> <p>Standard Features amber or natural bamboo top is 1" thick neapolitan bamboo top is ¾" thick 2¼" bamboo post</p>	<p>TH8JDP1-4242 TH8JDP1-3636</p>	42 36	42 36	28¾ 28¾	2635 2195	2994 2494
	<p>Specify Options 1. amber or natural bamboo color, see column B1; neapolitan bamboo, see column B2*</p>						

How To Order:

Specify model number and options listed with each product section. **Options marked with an asterisk are required.** Failure to do so will delay order processing. Options without an asterisk will be made standard if not otherwise specified.
 EX: TH1DPB1-4384.Natural.