

Walden

How To Order

1. State Quantity
2. Specify Model Number
3. Select The Molding (if applicable):
Walden WDM
Without Molding WOM
4. Wood Species is Walnut.
FSC certified veneers available upon request.

Select Standard Walnut Finish:

Paprika
Toffee
Tuscany
Amaretto
Sienna
Espresso
Mocha

5. Specify Options

Listed by each product group are options specific to those items. Options with an asterisk (*) are mandatory to make an order complete. Items without an asterisk will be made standard if not otherwise specified.

Laminate Top Option:

Black Granite L1
Sandstone L2
Light Stone L3
Greystone L4
Call Jofco to verify matching finish laminate.

Example:

(4) F4072.Walden Molding.Tuscany.

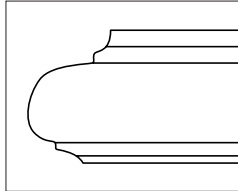

Federal Edge Profile
Accepts Laminate Top

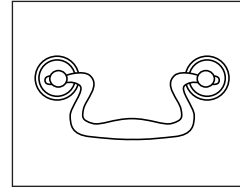

Walden Hardware
Antique Brass

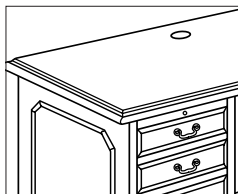

Grommet
Standard for some items--
check individual product section.

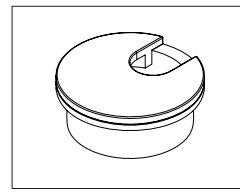

Top Grommet
Antique Brass
Matte Black

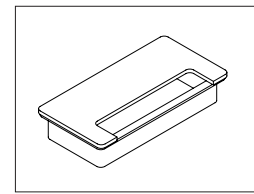

Optional End Panel Grommet
Antique Brass
Matte Black

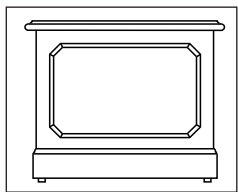

Walden Molding
Use WDM pricing column on
following pages.

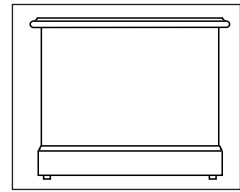

Without Molding
Use WOM pricing column
on following pages.

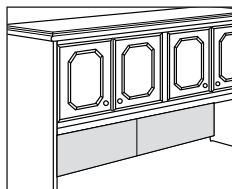

Tackboard and Tasklight are Standard

Stocked Pattern is Momentum Hue in Black, Char, Latte, Indigo, Fern or Dandelion. Additional patterns in the Jofco library can be found on pages 8-9.

Tasklight is dark metallic silver

Walden

Materials

All exterior surfaces of cases are walnut.

All wood is thoroughly air-seasoned before kiln drying and the moisture content is controlled to 6-8% at time of assembly.

All face veneers are flat cut and book-matched to ensure consistency of grain pattern. They are carefully selected for uniform appearance, figure and color.

All top veneers are reverse slip-matched.

All tops, panels and drawer fronts are to be glued with moisture resistant resin glues in a hot plate press. All assembly glues shall be non-organic and of polyvinyl acetate type.

Top Construction

Tops are 3-ply construction, 1 1/4" thick with hardwood rims.

All tops are securely fastened to cabinets by screws driven through interior framework.

Case Construction

Construction is full mortise and tenon.

All panels are 3/16" thick and 3-ply construction. Approach side of desk has a recessed middle back panel, securely fastened to each pedestal.

Pedestals are enclosed at bottom by a 3/4" base platform, securely fastened with screws.

Arm slides are 3-ply construction. They are banded on the front and two sides with solid lumber.

Drawer Construction

All drawer fronts are 5-ply construction with poplar core. Veneer grain runs in a vertical direction.

Drawer sides and backs are wood with top edges of sides completely rounded.

Veneered bottoms are framed into grooves on four sides. Bottoms are then glued, stapled, and reinforced with hand-fitted glue blocks.

All drawers are hand-fitted and equipped with heavy duty suspensions, which provide smooth, quiet, effortless closing.

Center drawers are standard on all desks. A solid hardwood pencil tray is provided in all center drawers.

Locking

Central locking is standard in all desks.

Locks on all desks are located in center drawer which locks both pedestal and center drawer.

Tackboard Textile

Tackboards are standard on most overhead storage 36" and wider.

Standard tackboard textile is Maharam Milestone in colorways listed below.

Colors:

Lychee

Ebony

Bison

Embrace

Vetiver

Pewter

For overhead storage without tackboard, please indicate 'no tackboard' rather than leave blank. There is no change in price.

Modification Pricing

Add modification pricing to list price.

Grommet, field installed \$38 each

Grommet, factory installed \$159 each

Access slot in back panel
(2 3/4" x 1 1/4") \$303

Wall-access opening in back panel
(10" x 12", 10" from floor) \$319

Printer access slots in tops or back panels
(17 3/16" x 1 3/16") \$358

Re-size standard tops or bases
(shorter or narrower) \$358

Flat cut or reverse shaped tops \$390

Modesty panels special lengths:
Up to 40" \$543
40" to 60" \$948

Use of non-standard laminates Call for Quote

Use of FSC-certified materials Call for Quote

Walden

L Shape Configuration

Model Number	Description	Page	Price
SP4066R	Single Pedestal Desk (without molding)	183	\$3193
ER4050L	19 1/4" d Return (without molding)	184	\$2448
Workstation List Price			\$5,641

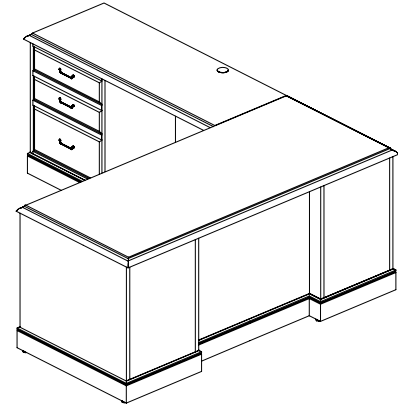

Double Pedestal Conference Desk with Storage

Model Number	Description	Page	Price
CF4072	Double Pedestal Conference Desk (without molding)	183	\$3859
CR4071-HD	Storage Credenza	186	\$3745
40HUWD72	Overhead Storage with Wood Doors	189	\$4222
Workstation List Price			\$11,826

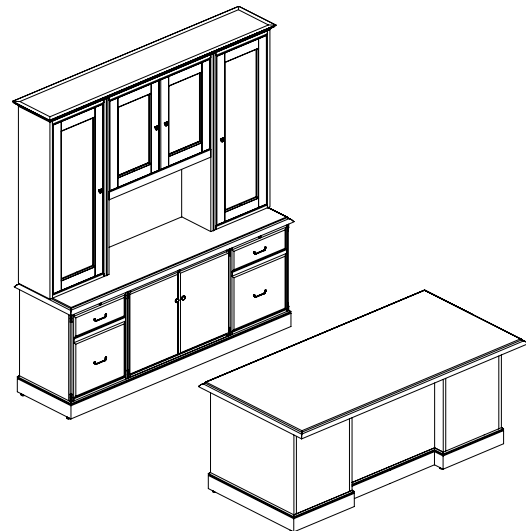

U Shape Configuration

Model Number	Description	Page	Price
SP4072L-36	Single Pedestal Conference Desk (walden molding)	183	\$4038
EUT4048	Bridge Top	185	\$ 902
CR402FDR	Open Corner Lateral File Credenza (walden molding)	186	\$3514
Workstation List Price			\$8,454

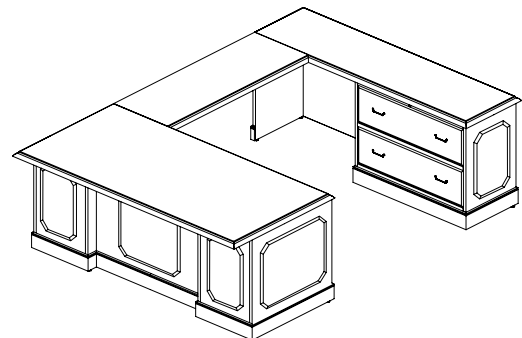



Walden

Double Pedestal Desk with Storage

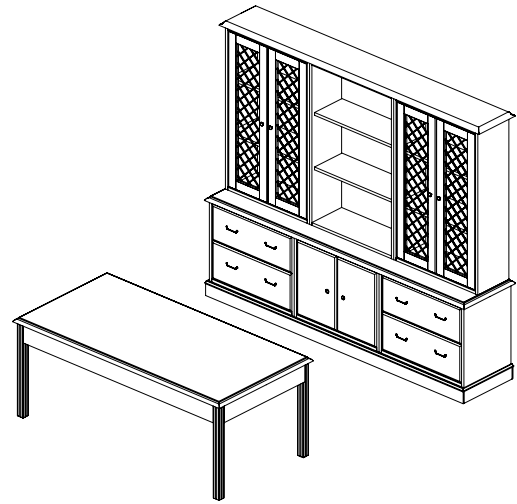
Model Number	Description	Page	Price
T4072-36	Work Table	184	\$2816
2FD4031NB (Qty 2)	File/File Pedestal	193	\$3508
HD4031NB	Hinge Door Pedestal	193	\$1462
TU4091	Modular Top	194	\$ 887
BU4090	Modular Base	194	\$ 742
HUDGR4047NB (Qty 2)	Modular Storage Unit with Grilled Doors	191	\$4154
HU4047NB	30" w Open Modular Storage	191	\$1453
TU4088-14	Modular Storage Top	191	\$ 838
Workstation List Price			\$15,860

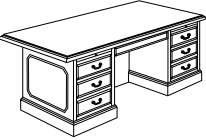
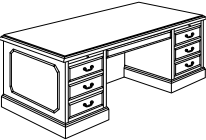

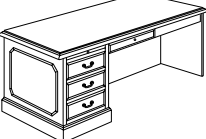
DESKS	DESCRIPTION/NOTES	MODEL	W	D	H	WT	WOM	WDM
 <p style="text-align: center;">QSP</p>	Double Pedestal Conference Desk Standard Features top shaped all sides locking drawers box/file drawer file drawer styled as two box drawers letter/legal filing, side to side center drawer arm slide writing shelf adjustable levelers/glides chassis size: 66 x 30 kneespace width: 29 kneespace height: 24% front overhang: 6	CF4072	72	36	29	335	3859	4202
		CF4072-QSP	72	36	29	335		4202
		Specify Options 1. finish* 2. walden molding or without molding* 3. laminate top available, no upcharge CF4072-QSP is available in walnut wood species with walden molding and your choice of standard finish in 15 working days						
	Double Pedestal Desk Standard Features top shaped all sides locking drawers box/file drawer file drawer styled as two box drawers letter/legal filing, side to side center drawer arm slide writing shelf adjustable levelers/glides F4072 kneespace width: 30½ F4066-30 kneespace width: 29 kneespace height: 24%	F4072	72	36	29	333	4336	4678
		F4066-30	66	30	29	305		3648
		Specify Options 1. finish* 2. walden molding or without molding* 3. laminate top available, no upcharge						
 <p style="text-align: center;">left shown</p> <p style="text-align: center;">QSP</p>	Single Pedestal Conference Desk Standard Features top shaped all sides locking drawers box/file drawer file drawer styled as two box drawers letter/legal filing, side to side center drawer arm slide writing shelf adjustable levelers/glides chassis size: 72 x 30 kneespace width: 52½ kneespace height: 24% front overhang: 7	SP4072L-36	72	36	29	340	3693	4038
		SP4072R-36	72	36	29	340		4038
		SP4072L-36-QSP	72	36	29	340		4038
		SP4072R-36-QSP	72	36	29	340		4038
		Specify Options 1. finish* 2. walden molding or without molding* 3. laminate top available, no upcharge SP4072L-36- or R-36-QSP is available in walnut wood species with walden molding and your choice of standard finish in 15 working days						
 <p style="text-align: center;">left shown</p>	Single Pedestal Desk Standard Features top shaped all sides locking drawers box/file drawer file drawer styled as two box drawers letter/legal filing, side to side center drawer arm slide writing shelf adjustable levelers/glides kneespace width: 46½ kneespace height: 24%	SP4066L	66	30	29	250	3193	3536
		SP4066R	66	30	29	250		3193
		Specify Options 1. finish* 2. walden molding or without molding* 3. laminate top available, no upcharge						

How To Order:

Specify model number and options listed with each product section. **Options marked with an asterisk are required.** Failure to do so will delay order processing. Options without an asterisk will be made standard if not otherwise specified.
 EX: F4072.Sienna.Walden Molding.

DESKS	DESCRIPTION/NOTES	MODEL	W	D	H	WT	PRICE
-------	-------------------	-------	---	---	---	----	-------

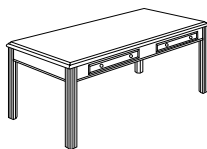

Work Table	T4072-36	72	36	29	150	2816
	T4060-30	60	30	29	109	

Standard Features
 top shaped all sides
 table tops are reverse slip-matched
 two drawers
 adjustable levelers/glides
 kneespace height: 23½

Specify Options
 1. finish*
 2. laminate top available, no upcharge

RETURNS	DESCRIPTION/NOTES	MODEL	W	D	H	WT	WOM	WDM
---------	-------------------	-------	---	---	---	----	-----	-----

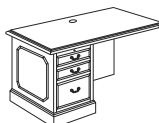

left shown

QSP

24" d Return	ER4050L-24	50	25½	29	183	2672	2808
	ER4050R-24	50	25½	29	183		
	ER4050L-24-QSP	50	25½	29	183	2672	2808
	ER4050R-24-QSP	50	25½	29	183		

Standard Features
 use with 72" w or 66" w desk
 reverse shaped connecting end
 rims are solid hardwood
 box/box/file pedestal
 letter/legal filing, front to back
 kneespace wire management
 3½" x 1⅞" wire management opening
 with black trim insert (top center) of
 modesty panel
 adjustable levelers/glides
 kneespace width: 28
 kneespace height: 27⅞

Specify Options
 1. finish*
 2. walden molding or without molding*
 3. laminate top available, no upcharge
 ER4050L-24 or R-24-QSP is available in walnut wood species with walden molding and your choice of standard finish in 15 working days

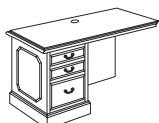

left shown

19-3/4" d Return	ER4050L	50	19¾	29	159	2448	2586
	ER4050R	50	19¾	29	159		

Standard Features
 use with 72" w or 66" w desk
 reverse shaped connecting end
 rims are solid hardwood
 box/box/file pedestal
 letter/legal filing, front to back
 kneespace wire management
 3½" x 1⅞" wire management opening
 with black trim insert (top center) of
 modesty panel
 adjustable levelers/glides
 kneespace width: 28
 kneespace height: 27⅞

Specify Options
 1. finish*
 2. walden molding or without molding*
 3. laminate top available, no upcharge

How To Order:

Specify model number and options listed with each product section. **Options marked with an asterisk are required.** Failure to do so will delay order processing. Options without an asterisk will be made standard if not otherwise specified.
 EX: F4072.Sienna.Walden Molding.

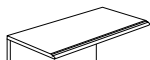
BRIDGES	DESCRIPTION/NOTES	MODEL	W	D	H	WT	PRICE
	Bridge Top with Modesty Panel	EU4048-24	48	24	29	92	1736
		EU4048	48	19 1/4	29	92	1703
		EU4048-QSP	48	19 1/4	29	92	1703

QSP

Standard Features

shaped two sides
 reverse shaped connecting ends
 veneer runs cross grain
 rims are solid hardwood
 kneespace wire management
 3 1/2" x 1 1/8" wire management opening
 with black trim insert (top center of kneespace)

Specify Options

1. finish*
 2. laminate top available, no upcharge

EU4048-QSP is available in walnut wood species and your choice of standard finish in 15 working days

	Bridge Top	EUT4048-24	48	24	1 1/4	52	920
		EUT4048	48	19 1/4	1 1/4	50	902

Standard Features

shaped two sides
 reverse shaped connecting ends
 veneer runs cross grain
 rims are solid hardwood

Specify Options

1. finish*
 2. laminate top available, no upcharge

How To Order:

Specify model number and options listed with each product section. **Options marked with an asterisk are required.** Failure to do so will delay order processing. Options without an asterisk will be made standard if not otherwise specified.
 EX: F4072.Sienna.Walden Molding.

CREDENZAS	DESCRIPTION/NOTES	MODEL	W	D	H	WT	PRICE
-----------	-------------------	-------	---	---	---	----	-------

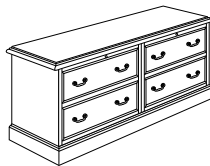

Lateral File Credenza	CR4071-4FD	71	19¼	29	295	4599
	CR4061-4FD	60½	19¼	19	284	

Standard Features
top shaped all sides
locking drawers
file/file drawers
letter/legal filing, side to side
adjustable levelers/glides

Specify Options
1. finish*
2. laminate top available, no upcharge
3. reinforced drawer bottom, add \$139 each drawer

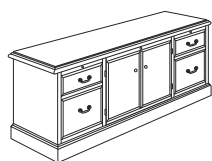

Storage Credenza	CR4071-HD	71	19¼	29	260	3745	
	CR4071-HD-QSP	71	19¼	29	260		3745
	CR4066-HD	66	19¼	29	255		3681

Standard Features
top shaped all sides
locking drawers and doors
box/file pedestals
letter/legal filing, front to back
hinged door compartment with adjustable shelf
adjustable levelers/glides

Specify Options
1. finish*
2. laminate top available, no upcharge
CR4071-HD-QSP is available in walnut wood species and your choice of standard finish in 15 working days

QSP



Kneespace Credenza	CR4071-KS	71	19¼	29	240	3462
	CR4066-KS	66	19¼	29	237	

Standard Features
top shaped all sides
locking drawers
box/file pedestals
letter/legal filing, front to back
kneespace wire management
3½" x 1½" wire management opening with black trim insert (top center)
CR4071-KS kneespace width: 30
CR4066-KS kneespace width: 25
kneespace height: 27¾
adjustable levelers/glides

Specify Options
1. finish*
2. laminate top available, no upcharge

CREDENZAS	DESCRIPTION/NOTES	MODEL	W	D	H	WT	WOM	WDM
-----------	-------------------	-------	---	---	---	----	-----	-----

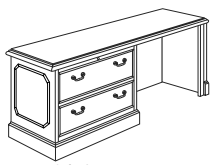

left shown

Open Corner Lateral File Credenza	CR402FDL	71	19¼	29	302	3377	3514	
	CR402FDR	71	19¼	29	302			3377
	CR402FDL-QSP	71	19¼	29	302			3514
	CR402FDR-QSP	71	19¼	29	302			3514

Standard Features
top shaped all sides
locking drawers
30" lateral file
letter/legal filing, side to side
kneespace wire management
3½" x 1½" wire management opening with black trim insert (top center) of modesty panel
adjustable levelers/glides

Specify Options
1. finish*
2. walden molding or without molding*
3. laminate top available, no upcharge
4. reinforced drawer bottom, add \$139 each drawer

CR402FDL or FDR-QSP is available in walnut wood species with walden molding and your choice of standard finish in 15 working days

QSP

CORNER UNITS	DESCRIPTION/NOTES	MODEL	W	D	H	WT	PRICE
--------------	-------------------	-------	---	---	---	----	-------



	Freestanding Corner Unit	CU4040-12FS	40¼	19¾	29	250	3066
--	---------------------------------	--------------------	-----	-----	----	-----	-------------

Standard Features

use with 19¾" deep returns, bridges or modular credenzas
top shaped all sides
2" top grommet
3½" x 1½" grommet top center of each back panel

Specify Options

1. finish*
2. laminate top available, no upcharge



	Corner Unit	CU4040-12	40¼	19¾	29	250	2891
--	--------------------	------------------	-----	-----	----	-----	-------------

Standard Features

use with 19¾" deep returns, bridges or modular credenzas
top shaped all sides
2" top grommet
connecting on left and right
3½" x 1½" grommet top center of each back panel

Specify Options

1. finish*
2. laminate top available, no upcharge

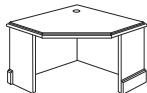

left shown

	Corner Unit	CU4040-12L	40¼	19¾	29	250	2919
		CU4040-12R	40¼	19¾	29	250	2919

Standard Features

CU4040-12L: use with 19¾" d returns, bridges or modular credenzas connecting on the left
CU4040-12R: use with 19¾" d returns, bridges or modular credenzas connecting on the right
top shaped all sides
3½" x 1½" grommet top center of each back panel

Specify Options

1. finish*
2. laminate top available, no upcharge

COMPUTER/PRINTER STAND	DESCRIPTION/NOTES	MODEL	W	D	H	WT	PRICE
------------------------	-------------------	-------	---	---	---	----	-------

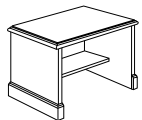

CRT4038FS shown

	Computer/Printer Stand	CRT4038FSM	38¾	23¼	29	131	2106
		CRT4038FS	38¾	23¼	29	131	1888

Standard Features

top shaped all sides
fixed inside shelf
access slot across top of back panel
CRT4038FS: without casters
CRT4038FSM: with casters

Specify Options

1. finish*

How To Order:

Specify model number and options listed with each product section. **Options marked with an asterisk are required.** Failure to do so will delay order processing. Options without an asterisk will be made standard if not otherwise specified.
EX: F4072.Sienna.Walden Molding.

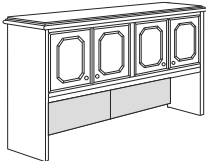
OVERHEAD STORAGE	DESCRIPTION/NOTES	MODEL	W	D	H	WT	A/COM	B	C	D	E	F	G	H	
	Overhead Storage for Credenza fits on a 71" credenza depth of end panel is 18" adjustable shelves inside dimensions: 24"h x 16¼" d tackboard and tasklights standard DRWD: doors with molding DLWD: doors without molding	BOS4069 (DRWD)	71	19¼	48¼	250	4696	4696	4696	4803	4827	4851	4900	4950	
		BOS4069-QSP	71	19¼	48¼	250			4696						
		BOS4069 (DLWD)	71	19¼	48¼	250	4421	4421	4421	4528	4553	4577	4626	4674	

QSP



top view, inside measurements

Specify Options

1. finish*
2. tackboard textiles, see pages 8-9*
3. locking doors, add \$222

BOS4069-QSP is available in walnut wood species with walden molding and your choice of standard finish in 15 working days

	Overhead Storage for Credenza fits on a 71" credenza depth of end panel is 18" adjustable shelves inside dimensions: 24"h x 16¼" d tackboard and tasklights standard NDR: without doors	BOS4069 (NDR)	71	19¼	48¼	237	4027	4027	4027	4134	4159	4183	4232	4282
---	--	----------------------	----	-----	-----	-----	-------------	-------------	-------------	-------------	-------------	-------------	-------------	-------------

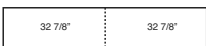

top view, inside measurements

Specify Options

1. finish*
2. tackboard textiles, see pages 8-9*

WALL MOUNTED STORAGE	DESCRIPTION/NOTES	MODEL	W	D	H	WT	PRICE
----------------------	-------------------	-------	---	---	---	----	-------

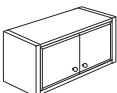

Wall Mounted Storage

BB4072	72	15	16	175	1891
BB4060	60	15	16	163	1813
BB4036	36	15	16	90	1603
BB4030	30	15	16	85	1555

Standard Features

does not match edge detail, straight cut attaching hardware provided

Specify Options

1. finish*
2. top
3. valance BBLV (specify length), add \$4 per inch
4. top BBTU40 (specify length), add \$6 per inch
5. locking doors: BB4072 and BB4060 add \$222, BB4036 and BB4030 add \$111

How To Order:

Specify model number and options listed with each product section. **Options marked with an asterisk are required.** Failure to do so will delay order processing. Options without an asterisk will be made standard if not otherwise specified.
 EX: F4072.Sienna.Walden Molding.

OVERHEAD STORAGE WITH CORNICE TOP	DESCRIPTION/NOTES	MODEL	W	D	H	WT	A/COM	B	C	D	E	F	G	H
-----------------------------------	-------------------	-------	---	---	---	----	-------	---	---	---	---	---	---	---

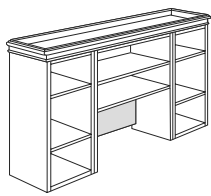

Open Overhead Storage

40HU72

72 13 50 195 **3536 3536 3536 3597 3611 3625 3652 3681**

Standard Features

top shaped three sides, back side flat
1" wire access slot across bottom of back panel
tackboard and tasklights standard

Specify Options

1. finish*
2. tackboard textiles, see pages 8-9*
3. glass shelves & halogen lights, add \$599
4. glass shelves, add \$321



top view, inside measurements

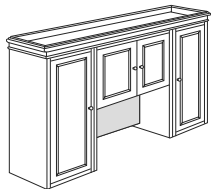

Overhead Storage with Wood Doors

40HUWD72

72 13 50 210 **4222 4222 4222 4284 4297 4311 4339 4366**

Standard Features

top shaped three sides, back side flat
1" wire access slot across bottom of back panel
tackboard and tasklights standard

Specify Options

1. finish*
2. tackboard textiles, see pages 8-9*
3. locking doors, add \$334



top view, inside measurements

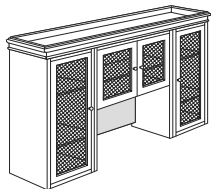

Overhead Storage with Grilled Doors

40HUGR72

72 13 50 210 **4222 4222 4222 4284 4297 4311 4339 4366**

Standard Features

top shaped three sides, back side flat
1" wire access slot across bottom of back panel
tackboard and tasklights standard

Specify Options

1. finish*
2. tackboard textiles, see pages 8-9*
3. glass shelves & halogen lights, add \$599
4. glass shelves, add \$321
5. locking doors, add \$334



top view, inside measurements

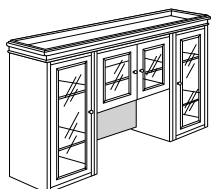

Overhead Storage with Glass Doors

40HUGL72

72 13 50 210 **4222 4222 4222 4284 4297 4311 4339 4366**

Standard Features

top shaped three sides, back side flat
1" wire access slot across bottom of back panel
tackboard and tasklights standard

Specify Options

1. finish*
2. tackboard textiles, see pages 8-9*
3. glass shelves & halogen lights, add \$599
4. glass shelves, add \$321
5. locking doors, add \$334



top view, inside measurements

How To Order:

Specify model number and options listed with each product section. **Options marked with an asterisk are required.** Failure to do so will delay order processing. Options without an asterisk will be made standard if not otherwise specified.
EX: F4072.Sienna.Walden Molding.

STEP-UP OVERHEAD STORAGE	DESCRIPTION/NOTES	MODEL	W	D	H	WT	A/COM	B	C	D	E	F	G	H
--------------------------	-------------------	-------	---	---	---	----	-------	---	---	---	---	---	---	---

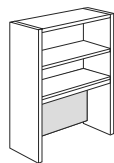

Step-Up Open Overhead Storage

HU4023NB

29% 13 47 78

1885 1885 1885 1946 1960 1974 2002 2029

Standard Features

tackboard and tasklights standard
open area is 27½" w x 21¼" h
upper shelf adjustable
lower shelf fixed
1" wire access slot across bottom of back panel

Specify Options

1. finish*
2. tackboard textiles, see pages 8-9*
3. glass shelves & halogen lights, add \$301
4. glass shelves, add \$105

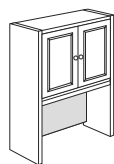

Step-Up Overhead Storage with Wood Doors

HUWD4023NB

29% 13 47 90

2483 2483 2483 2544 2559 2572 2600 2627

Standard Features

tackboard and tasklights standard
open area is 27½" w x 21¼" h
one adjustable shelf

Specify Options

1. finish*
2. tackboard textiles, see pages 8-9*
3. locking doors, add \$111

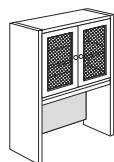

Step-Up Overhead Storage with Grilled Doors

HUDGR4023NB

29% 13 47 85

2483 2483 2483 2544 2559 2572 2600 2627

Standard Features

tackboard and tasklights standard
open area is 27½" w x 21¼" h
one adjustable shelf
1" wire access slot across bottom of back panel

Specify Options

1. finish*
2. tackboard textiles, see pages 8-9*
3. glass shelves & halogen lights, add \$301
4. glass shelves, add \$105
5. locking doors, add \$111

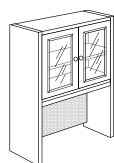

Step-Up Overhead Storage with Glass Doors

HUDGL4023NB

29% 13 47 90

2483 2483 2483 2544 2559 2572 2600 2627

Standard Features

tackboard and tasklights standard
open area is 27½" w x 21¼" h
one adjustable shelf
1" wire access slot across bottom of back panel

Specify Options

1. finish*
2. tackboard textiles, see pages 8-9*
3. glass shelves & halogen lights, add \$301
4. glass shelves, add \$105
5. locking doors, add \$111

How To Order:

Specify model number and options listed with each product section. **Options marked with an asterisk are required.** Failure to do so will delay order processing. Options without an asterisk will be made standard if not otherwise specified.
EX: F4072.Sienna.Walden Molding.

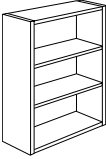
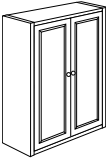
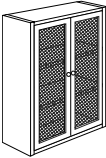
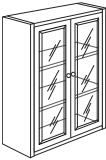
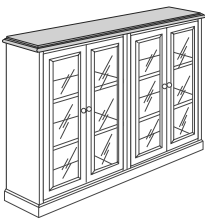
MODULAR STORAGE UNITS	DESCRIPTION/NOTES	MODEL	W	D	H	WT	PRICE
	Open Modular Storage Unit	HU4047NB	29%	13	47	83	1453
	Standard Features two adjustable shelves	Specify Options 1. finish* 2. glass shelves & halogen lights, add \$398 3. glass shelves, add \$203					
	Modular Storage Unit with Wood Doors	HUWD4047NB	29%	13	47	95	2077
	Standard Features two adjustable shelves	Specify Options 1. finish* 2. locking doors, add \$111					
	Modular Storage Unit with Grilled Doors	HUDGR4047NB	29%	13	47	90	2077
	Standard Features two adjustable shelves	Specify Options 1. finish* 2. glass shelves & halogen lights, add \$398 3. glass shelves, add \$203 4. locking doors, add \$111					
	Modular Storage Unit with Glass Doors	HUDGL4047NB	29%	13	47	95	2077
	Standard Features two adjustable shelves	Specify Options 1. finish* 2. glass shelves & halogen lights, add \$398 3. glass shelves, add \$203 4. locking doors, add \$111					
	Modular Storage Top	TU40118-14 TU4088-14 TU4059-14 TU4029-14	120	13%	1 1/4	43	1403
	Standard Features used to make floor-based bookcases top shaped three sides, back side flat TU40118-14: use with four bookcases TU4088-14: use with three bookcases TU4059-14: use with two bookcases TU4029-14: use with one bookcase	Specify Options 1. finish*	90 1/2	13%	1 1/4	35	838
			60%	13%	1 1/4	28	543
			31%	13%	1 1/4	15	330

How To Order:

Specify model number and options listed with each product section. **Options marked with an asterisk are required.** Failure to do so will delay order processing. Options without an asterisk will be made standard if not otherwise specified.
EX: F4072.Sienna.Walden Molding.

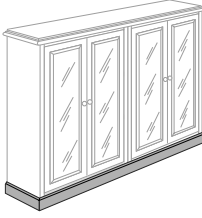
MODULAR STORAGE UNITS	DESCRIPTION/NOTES	MODEL	W	D	H	WT	PRICE
	Modular Base used to make floor-based bookcases shaped three sides, back side flat BU4088-14: use with three bookcases BU4059-14: use with two bookcases BU4030-14: use with one bookcase	BU4088-14	90	13%	4%	23	681
		BU4059-14	60%	13%	4%	17	513
		BU4030-14	30%	13%	4%	10	336

Standard Features

used to make floor-based bookcases shaped three sides, back side flat
 BU4088-14: use with three bookcases
 BU4059-14: use with two bookcases
 BU4030-14: use with one bookcase

Specify Options

1. finish*

	Modular Storage Cornice Top use on overhead storage units when placed on top of credenzas or modular units top shaped three sides, back side flat HT4091: use with two or three bookcases HT4061: use with two bookcases HT4031: use with one bookcase	HT4091	88½	13%	3	20	768
		HT4061	59½	13%	3	13	516
		HT4031	30½	13%	3	9	346

Standard Features

use on overhead storage units when placed on top of credenzas or modular units
 top shaped three sides, back side flat
 HT4091: use with two or three bookcases
 HT4061: use with two bookcases
 HT4031: use with one bookcase

Specify Options

1. finish*

	Overhead Storage Filler Panel use with HT4091 and two bookcases	HFP4029	29%	13	¾	10	292
--	---	----------------	-----	----	---	----	------------

Standard Features

use with HT4091 and two bookcases

Specify Options

1. finish*

How To Order:

Specify model number and options listed with each product section. **Options marked with an asterisk are required.** Failure to do so will delay order processing. Options without an asterisk will be made standard if not otherwise specified.
 EX: F4072.Sienna.Walden Molding.

MODULAR COMPONENTS	DESCRIPTION/NOTES	MODEL	W	D	H	WT	PRICE
	Open Pedestal	B4031	31	19¼	29	105	1628
		B4031N	30¾	19¾	27¾	85	1332
		B4031NB	29¾	18	23½	71	1031
	Standard Features top shaped all sides adjustable levelers/glides one adjustable shelf B4031N: without top B4031NB: without top/base	Specify Options 1. finish* 2. laminate top available, no upcharge					
	Box/Box/File Pedestal	FD4031	31	19¼	29	142	2350
		FD4031N	30¾	19¾	27¾	122	2054
		FD4031NB	29¾	18	23½	108	1754
	Standard Features top shaped all sides locking drawers letter/legal filing, side to side adjustable levelers/glides FD4031N: without top FD4031NB: without top/base	Specify Options 1. finish* 2. laminate top available, no upcharge 3. reinforced drawer bottom, add \$139 each					
	File/File Pedestal	2FD4031	31	19¼	29	141	2350
		2FD4031N	30¾	19¾	27¾	121	2054
		2FD4031NB	29¾	18	23½	107	1754
	Standard Features top shaped all sides locking drawers letter/legal filing, side to side adjustable levelers/glides 2FD4031N: without top 2FD4031NB: without top/base	Specify Options 1. finish* 2. laminate top available, no upcharge 3. reinforced drawer bottom, add \$139 each					
	Hinge Door Pedestal	HD4031	31	19¼	29	122	2056
		HD4031N	30¾	19¾	27¾	102	1762
		HD4031NB	29¾	18	23½	88	1462
	Standard Features top shaped all sides one adjustable shelf adjustable levelers/glides locking doors HD4031N: without top HD4031NB: without top/base	Specify Options 1. finish* 2. laminate top available, no upcharge					
	Box/Box/File Pedestal	F4020	21¼	19¼	29	101	1857
		F4020N	21¼	19¾	27¾	93	1510
		F4020NB	21¼	18	23½	81	1294
	Standard Features top shaped all sides locking drawers letter/legal filing, front to back adjustable levelers/glides F4020N: without top F4020NB: without top/base	Specify Options 1. finish* 2. laminate top available, no upcharge					

How To Order:

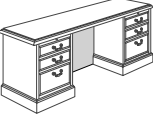
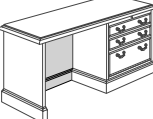
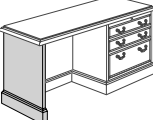

Specify model number and options listed with each product section. **Options marked with an asterisk are required.** Failure to do so will delay order processing. Options without an asterisk will be made standard if not otherwise specified.
EX: F4072.Sienna.Walden Molding.

MODULAR COMPONENTS	DESCRIPTION/NOTES	MODEL	W	D	H	WT	PRICE
	File/File Pedestal	2F4020	21¼	19¼	29	102	1857
		2F4020N	21¼	19¼	27¼	92	1510
		2F4020NB	21¼	18	23½	80	1294
		Standard Features top shaped all sides locking drawers file/file pedestal letter/legal filing, front to back adjustable levelers/glides 2F4020N: without top 2F4020NB: without top/base	Specify Options 1. finish* 2. laminate top available, no upcharge				
	Modular Top	TU40120	120	19¼	1¼	91	1568
		TU4091	90½	19¼	1¼	76	887
		TU4071	71	19¼	1¼	56	686
		TU4066	66	19¼	1¼	52	572
		TU4061	60½	19¼	1¼	48	545
		TU4036	35½	19¼	1¼	23	376
		TU4031	31½	19¼	1¼	20	340
		TU4020	21¼	19¼	1¼	15	325
			Standard Features top shaped all sides TU40120: use with four 31" modular units TU4091: use with three 31" modular units TU4071: use with two 20" and one 31" modular units or two 36" lateral files TU4066: use with miscellaneous units TU4061: use with two 31" or three 20" modular units TU4031: use with one 31" modular unit TU4020: use with one 20" modular unit	Specify Options 1. finish*			
	Modular Base	BU4090	90	19¼	4¾	34	742
		BU4071	69¾	19¼	4¾	26	594
		BU4070	70½	19¼	4¾	26	594
		BU4061	60¾	19¼	4¾	22	530
		BU4060	60½	19¼	4¾	22	530
		BU4031	30¾	19¼	4¾	14	343
		BU4020	21	19¼	4¾	12	250
			Standard Features BU4090: use with three 31" modular units BU4071: use with two 36" lateral file units BU4070: use with two 20" and one 31" modular units BU4061: use with three 20" modular units BU4060: use with two 31" modular units BU4031: use with one 31" modular unit BU4020: use with one 20" modular unit	Specify Options 1. finish*			
	Modular Center Support Panel	PE4011	11	1	27¼	14	401
			Standard Features used in making credenzas and workstations use one one for spans between 48-72"; use two for spans over 72"	Specify Options 1. finish*			

MODULAR COMPONENTS	DESCRIPTION/NOTES	MODEL	W	D	H	WT	PRICE
	Modesty Panel Standard Features used in making credenzas and workstations use in place of a 31" modular unit	MP4030	29%	7/8"	27 3/4"	24	504
	Specify Options 1. finish*						
	Modesty Panel Standard Features use in place of a 31" modular unit with end panel	MP4029	28%	7/8"	27 3/4"	23	493
	Specify Options 1. finish*						
	Modular End Panel Standard Features PE4028: used in making freestanding credenzas PE4028L or R: used in making handed credenzas	PE4028	18	1	27 3/4"	14	427
		PE4028L	18	1	27 3/4"	14	431
		PE4028R	18	1	27 3/4"	14	431
		Specify Options 1. finish*					

How To Order:

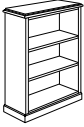
Specify model number and options listed with each product section. **Options marked with an asterisk are required.** Failure to do so will delay order processing. Options without an asterisk will be made standard if not otherwise specified.
 EX: F4072.Sienna.Walden Molding.

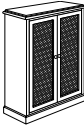
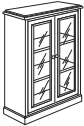
STORAGE UNITS	DESCRIPTION/NOTES	MODEL	W	D	H	WT	PRICE
	Open Storage Unit	BC40-1	31 3/8	13 3/8	53	108	2058
	<p>Standard Features top & base shaped three sides, back side flat two adjustable shelves</p> <p>Specify Options 1. finish* 2. glass shelves & halogen lights, add \$398 3. glass shelves, add \$203</p>						
	Storage Unit with Wood Doors	BCWD40-1	31 3/8	13 3/8	53	118	2748
	<p>Standard Features top & base shaped three sides, back side flat two adjustable shelves</p> <p>Specify Options 1. finish* 2. locking doors, add \$111</p>						
	Storage Unit with Grilled Doors	BCGR40-1	31 3/8	13 3/8	53	115	2748
	<p>Standard Features top & base shaped three sides, back side flat two adjustable shelves</p> <p>Specify Options 1. finish* 2. glass shelves & halogen lights, add \$398 3. glass shelves, add \$203 4. locking doors, add \$111</p>						
	Storage Unit with Glass Doors	BCGL40-1	31 3/8	13 3/8	53	120	2748
	<p>Standard Features top & base shaped three sides, back side flat two adjustable shelves</p> <p>Specify Options 1. finish* 2. glass shelves & halogen lights, add \$398 3. glass shelves, add \$203 4. locking doors, add \$111</p>						

How To Order:

Specify model number and options listed with each product section. **Options marked with an asterisk are required.** Failure to do so will delay order processing. Options without an asterisk will be made standard if not otherwise specified.
EX: F4072.Sienna.Walden Molding.

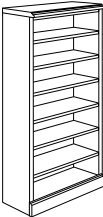
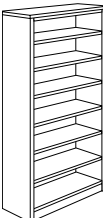
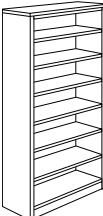
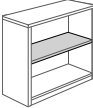
BOOKCASES	DESCRIPTION/NOTES	MODEL	W	D	H	WT	PRICE					
	Open Bookcase with Shaped Front Top Standard Features tops shaped front only unfinished back consists of black composite material properly secure to prevent tipping, (hardware not included) BC4084: five adjustable shelves, one fixed shelf BC4072: four adjustable shelves, one fixed shelf BC4060: four adjustable shelves BC4048: three adjustable shelves BC4036: two adjustable shelves BC4030: one adjustable shelf	BC4084 BC4072 BC4060 BC4048 BC4036 BC4030	36 36 36 36 36 36	12 12 12 12 12 12	84% 72% 60% 48% 36% 30%	143 130 104 96 72 61	2355 2142 1872 1555 1376 1209					
		Specify Options 1. finish* 2. heavy duty S40-5 shelves, add \$106 each 3. finished back, add \$313 4. adjustable leveling glides, add \$139										
			Open Bookcase with Flat-Rimmed Top Standard Features ¾" thick flat-rimmed top ¾" adjustable shelves unfinished back consists of black composite material properly secure to prevent tipping, (hardware not included) BC84: five adjustable shelves, one fixed BC72: four adjustable shelves, one fixed BC60: four adjustable shelves BC48: three adjustable shelves BC36: two adjustable shelves BC30: one adjustable shelf	BC84 BC72 BC60 BC48 BC36 BC30	36 36 36 36 36 36	12 12 12 12 12 12	84 72 60 48 36 30	143 130 104 96 72 61	1881 1717 1490 1240 1040 913			
				Specify Options 1. veneer* 2. finish* 3. heavy duty S40-5 shelves, add \$106 each 4. finished back, add \$313 5. adjustable leveling glides, add \$139								
					QSP Open Bookcase with Flat-Rimmed Top Standard Features ¾" thick flat-rimmed top ¾" adjustable shelves unfinished back consists of black composite material properly secure to prevent tipping, (hardware not included) BC84: five adjustable shelves, one fixed BC72: four adjustable shelves, one fixed BC60: four adjustable shelves BC48: three adjustable shelves	BC84-QSP BC72-QSP BC60-QSP BC48-QSP	36 36 36 36	12 12 12 12	84 72 60 48	143 130 104 96	1881 1717 1490 1240	
						Specify Options 1. veneer* 2. finish* available in walnut, cherry or maple wood species and your choice of standard finish in 15 working days						
							Heavy Duty Shelf Standard Features 1" heavy duty	S40-5	34%	11%	1	9
Specify Options 1. finish*												

QSP

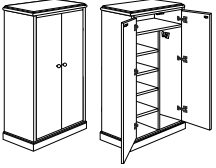
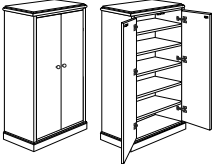
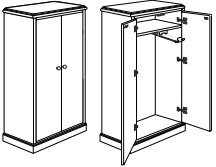

How To Order:

Specify model number and options listed with each product section. **Options marked with an asterisk are required.** Failure to do so will delay order processing. Options without an asterisk will be made standard if not otherwise specified.
 EX: F4072.Sienna.Walden Molding.

STORAGE/WARDROBES	DESCRIPTION/NOTES	MODEL	W	D	H	WT	PRICE
	<p>Storage/Wardrobe Unit</p> <p>Standard Features top shaped all sides top shelf fixed four adjustable shelves on left coat storage on right hinged doors swing 180 degrees adjustable levelers/glides</p>	WD4030BC	30	19 $\frac{3}{4}$	77 $\frac{1}{4}$	300	5585
	<p>Specify Options</p> <ol style="list-style-type: none"> 1. finish* 2. locking doors, add \$111 3. 90 degree hinged door swing, no upcharge 						
	<p>Storage Unit</p> <p>Standard Features top shaped all sides one fixed and four adjustable shelves hinged doors swing 180 degrees adjustable levelers/glides</p>	WD4030S	30	19 $\frac{3}{4}$	77 $\frac{1}{4}$	300	5466
	<p>Specify Options</p> <ol style="list-style-type: none"> 1. finish* 2. locking doors, add \$111 3. 90 degree hinged door swing, no upcharge 						
	<p>Wardrobe Unit</p> <p>Standard Features top shaped all sides one fixed shelf and pull out coat hanger hinged doors swing 180 degrees adjustable levelers/glides</p>	WD4030	30	19 $\frac{3}{4}$	77 $\frac{1}{4}$	215	5051
	<p>Specify Options</p> <ol style="list-style-type: none"> 1. finish* 2. locking doors, add \$111 3. 90 degree hinged door swing, no upcharge 						

How To Order:

Specify model number and options listed with each product section. **Options marked with an asterisk are required.** Failure to do so will delay order processing. Options without an asterisk will be made standard if not otherwise specified.
 EX: F4072.Sienna.Walden Molding.

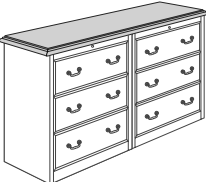
LATERAL FILES	DESCRIPTION/NOTES	MODEL	W	D	H	WT	PRICE	
	Four Drawer Lateral File	4TLFD-4	39 $\frac{3}{4}$	20 $\frac{1}{4}$	53 $\frac{1}{4}$	420	4133	
		4TLFD-4N	37 $\frac{3}{4}$	19	52	383	3740	
	Standard Features top shaped all sides locking drawers letter/legal filing, front to back or side to side adjustable levelers/glides 4TLFD-4N: without top	Specify Options 1. finish* 2. reinforced drawer bottom, add \$139 each drawer						
	Three Drawer Lateral File	4TLFD-3	39 $\frac{3}{4}$	20 $\frac{1}{4}$	49 $\frac{1}{2}$	280	3307	
		4TLFD-3N	37 $\frac{3}{4}$	19	47 $\frac{1}{2}$	255	2911	
	Standard Features top shaped all sides locking drawers letter/legal filing, front to back or side to side adjustable levelers/glides 4TLFD-3N: without top	Specify Options 1. finish* 2. reinforced drawer bottom, add \$139 each drawer						
	Two Drawer Lateral File	2FD4036	36	19 $\frac{1}{4}$	29	200	2880	
		2FD4036-QSP	36	19 $\frac{1}{4}$	29	200	2880	
		2FD4036N	35 $\frac{1}{2}$	19 $\frac{1}{4}$	27 $\frac{1}{4}$	190	2544	
		2FD4036NB	34 $\frac{1}{4}$	18	23 $\frac{1}{2}$	170	2205	
	Standard Features top shaped all sides locking drawers file/file pedestal letter/legal filing, side to side adjustable levelers/glides 2FD4036N: without top 2FD4036NB: without top/base	Specify Options 1. finish* 2. laminate top available, no upcharge 3. reinforced drawer bottom, add \$139 each drawer						
	QSP	2FD4036-QSP is available in walnut wood species and your choice of standard finish in 15 working days						
	Lateral File Top	TU40114	114 $\frac{3}{8}$	20 $\frac{3}{4}$	1 $\frac{1}{4}$	75	1520	
		TU4077	77	20 $\frac{3}{4}$	1 $\frac{1}{4}$	64	743	
	Standard Features TU40114: use with three lateral files TU4077: use with two lateral files	Specify Options 1. finish*						

How To Order:

Specify model number and options listed with each product section. **Options marked with an asterisk are required.** Failure to do so will delay order processing. Options without an asterisk will be made standard if not otherwise specified.
 EX: F4072.Sienna.Walden Molding.

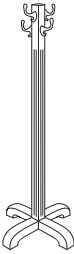
ACCESSORIES	DESCRIPTION/NOTES	MODEL	W	D	H	WT	PRICE
	Keyboard Drawer Standard Features use with CR4071-KS flip front drawer	KBFD40-30 Specify Options 1. finish*	29½	14½	4½	19	474
	<hr/>						
	Center Drawer Standard Features used in custom credenzas only	CD4030 Specify Options 1. finish*	29½	16½	2¾	23	293
	<hr/>						
	Costumer Standard Features	CO4021 Specify Options 1. finish*	20	20	71¼	20	585
	<hr/>						

How To Order:

Specify model number and options listed with each product section. **Options marked with an asterisk are required.** Failure to do so will delay order processing. Options without an asterisk will be made standard if not otherwise specified.
 EX: F4072.Sienna.Walden Molding.

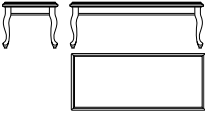
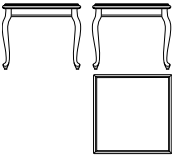
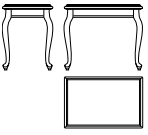
OCCASSIONAL TABLES	DESCRIPTION/NOTES	MODEL	W	D	H	WT	PRICE
	<p>Coffee Table</p> <p>Standard Features top is 1 1/4" thick, 3-ply construction flat cut, book-matched vertical veneers veneer is reverse slip-matched shipped KD</p>	COFTQ58048	48	20	16	65	1204
	<p>Specify Options 1. finish* 2. laminate top available, no upcharge</p>						
	<p>End Table</p> <p>Standard Features top is 1 1/4" thick, 3-ply construction flat cut, book-matched vertical veneers veneer is reverse slip-matched shipped KD</p>	STQS8028	28	28	23	35	1025
	<p>Specify Options 1. finish* 2. laminate top available, no upcharge</p>						
	<p>End Table</p> <p>Standard Features top is 1 1/4" thick, 3-ply construction flat cut, book-matched vertical veneers veneer is reverse slip-matched shipped KD</p>	ETQS8028	28	18	23	25	933
	<p>Specify Options 1. finish* 2. laminate top available, no upcharge</p>						

How To Order:

Specify model number and options listed with each product section. **Options marked with an asterisk are required.** Failure to do so will delay order processing. Options without an asterisk will be made standard if not otherwise specified.
 EX: F4072.Sienna.Walden Molding.

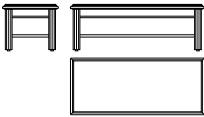
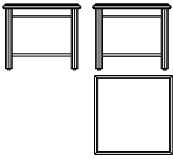
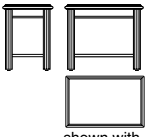
OCCASIONAL TABLES	DESCRIPTION/NOTES	MODEL	W	D	H	WT	PRICE
 <p>shown with optional shelf</p>	<p>Coffee Table</p> <p>Standard Features top is 1 1/4" thick, 3-ply construction flat cut, book-matched vertical veneers veneer is reverse slip-matched shipped KD</p>	<p>COFT8048</p>	48	20	16	65	1100
	<p>Specify Options 1. finish* 2. laminate top available, no upcharge 3. S80-3 shelf, add \$188</p>						
 <p>shown with optional shelf</p>	<p>End Table</p> <p>Standard Features top is 1 1/4" thick, 3-ply construction flat cut, book-matched vertical veneers veneer is reverse slip-matched shipped KD</p>	<p>ST8028</p>	28	28	23	35	935
	<p>Specify Options 1. finish* 2. laminate top available, no upcharge 3. S80-2 shelf, add \$173</p>						
 <p>shown with optional shelf</p>	<p>End Table</p> <p>Standard Features top is 1 1/4" thick, 3-ply construction flat cut, book-matched vertical veneers veneer is reverse slip-matched shipped KD</p>	<p>ET8028</p>	28	18	23	25	885
	<p>Specify Options 1. finish* 2. laminate top available, no upcharge 3. S80-1 shelf, add \$139</p>						

How To Order:

Specify model number and options listed with each product section. **Options marked with an asterisk are required.** Failure to do so will delay order processing. Options without an asterisk will be made standard if not otherwise specified.
EX: F4072.Sienna.Walden Molding.